

**DAC85H
DAC87H**

**MILITARY
VERSION
AVAILABLE**

Monolithic 12-Bit DIGITAL-TO-ANALOG CONVERTERS

FEATURES

- **INDUSTRY STANDARD PINOUT**
- **LOW POWER DISSIPATION: 345mW**
- **FULL $\pm 10V$ SWING WITH $V_{CC} = \pm 12VDC$**
- **DIGITAL INPUTS ARE TTL- AND CMOS-COMPATIBLE**
- **GUARANTEED SPECIFICATIONS WITH $\pm 12V$ AND $\pm 15V$ SUPPLIES**
- **SINGLE-CHIP DESIGN**
- **$\pm 1/2LSB$ MAXIMUM NONLINEARITY, $-55^{\circ}C$ to $+125^{\circ}C$**
- **GUARANTEED MONOTONICITY, $-55^{\circ}C$ TO $+125^{\circ}C$**
- **PACKAGE: Hermetic Side-brazed Ceramic DIP**
- **SETTLING TIME: $4\mu s$ max to $\pm 0.01\%$ of Full Scale**

output amplifier feedback resistors, as well as low integral and differential linearity errors. Innovative circuit design enables the DAC85 and DAC87 to operate at supply voltages as low as $\pm 11.4V$ with no loss in performance or accuracy over any range of output voltage. Ease of use has been enhanced by eliminating the need for a +5V logic power supply. The lower power dissipation of the 118 mil by 121 mil chip results in higher reliability and greater long term stability.

Both models are available in a hermetic, side-brazed, ceramic DIP. The DAC85H is specified over the industrial temperature range of $-25^{\circ}C$ to $+85^{\circ}C$. The DAC87H is specified over the entire military temperature range of $-55^{\circ}C$ to $+125^{\circ}C$.

DESCRIPTION

These monolithic digital-to-analog converters are pin-for-pin equivalent to the industry standard DAC85 and DAC87 first introduced by Burr-Brown. Their single-chip design includes the output amplifier and provides a highly stable reference capable of supplying up to 2.5mA to an external load without degradation of D/A performance.

These converters use proven circuit techniques to provide accurate and reliable performance over temperature and power supply variations. The use of a buried zener diode as the bias for the internal reference contributes to the high stability and low noise of the device. Advanced methods of laser trimming result in precision output current and

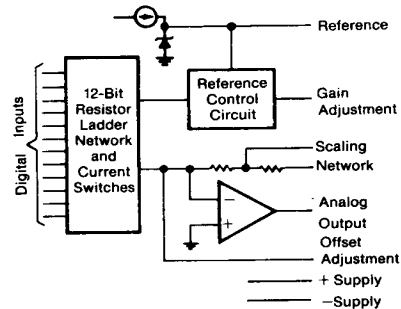

International Airport Industrial Park - P.O. Box 11400 - Tucson, Arizona 85734 - Tel. (602) 746-1111 - Twx: 910-952-1111 - Cable: BBRCORP - Telex: 66-6491

PDS-681A

SPECIFICATIONS

ELECTRICAL

Typical at +25°C and $\pm V_{CC} = 12V$ or $15V$ unless otherwise noted.

| MODEL | DAC85H | | | DAC87H | | | UNITS |
|--|------------|-----------------------------------|-------------|--------|-----|-------------|-------------------------|
| | MIN | TYP | MAX | MIN | TYP | MAX | |
| DIGITAL INPUT | | | | | | | |
| Resolution | | | 12 | | | * | Bits |
| Logic Levels (0°C to +70°C) ⁽¹⁾ : | | | | | | | |
| V_{IH} (Logic "1") | +2 | | +16.5 | * | | * | VDC |
| V_{IL} (Logic "0") | 0 | | +0.8 | * | | * | VDC |
| I_{IH} ($V_{IH} = +2.4V$) | | | +20 | | | * | μA |
| I_{IL} ($V_{IL} = +0.4V$) | | | -180 | | | * | μA |
| ACCURACY (at 25°C) | | | | | | | |
| Linearity Error | | $\pm 1/4$ | $\pm 1/2$ | | * | * | LSB |
| Differential Linearity Error | | $\pm 1/2$ | $\pm 3/4$ | | * | * | LSB |
| Gain Error ⁽²⁾ | | ± 0.1 | ± 0.2 | | | ± 0.1 | % |
| Offset Error ⁽²⁾ | | ± 0.5 | ± 0.1 | | | ± 0.05 | % of FSR ⁽³⁾ |
| DRIFT (over specification temperature range) ⁽⁴⁾ | | | | | | | |
| Total bipolar drift (includes gain, offset, and linearity drifts) | | ± 10 | ± 25 | | | ± 30 | ppm of FSR/°C |
| Total Error (over specification temperature range) ⁽⁵⁾ : Unipolar | | | ± 0.2 | | | * | % of FSR |
| Bipolar | | | ± 0.12 | | | ± 0.2 | % of FSR |
| Gain: Including Internal Reference | | | ± 20 | | * | * | ppm/°C |
| Excluding Internal Reference | | ± 5 | ± 10 | | * | * | ppm/°C |
| Unipolar Offset | | | ± 3 | | | * | ppm of FSR/°C |
| Bipolar Offset | | | ± 10 | | | * | ppm of FSR/°C |
| Differential Linearity | | | $\pm 3/4$ | | | * | LSB |
| Linearity Error | | $\pm 1/4$ | $\pm 1/2$ | | * | * | LSB |
| Monotonicity Guaranteed | -25 | | +85 | -55 | | +125 | °C |
| CONVERSION SPEED, V_{OUT} models | | | | | | | |
| Settling Time to $\pm 0.012\%$ of FSR | | | | | | | |
| For FSR change (2k Ω 500pF load): | | | | | | | |
| with 10k Ω Feedback | | 3 | 4 | | * | * | μs |
| with 5k Ω Feedback | | 2 | 3 | | * | * | μs |
| For 1LSB Change | | 1 | | | * | * | μs |
| Slew Rate | 10 | | | * | | | V/ μs |
| CONVERSION SPEED, I_{OUT} models | | | | | | | |
| Settling Time to $\pm 0.01\%$ of FSR | | | | | | | |
| For FSR change: 10 Ω to 100 Ω load | | 300 | | | * | | ns |
| 1k Ω load | | 1 | | | * | | μs |
| ANALOG OUTPUT, V_{OUT} models | | | | | | | |
| Ranges | | $\pm 2.5, \pm 5, \pm 10, +5, +10$ | | | | * | V |
| Output Current ⁽⁶⁾ | ± 5 | | | * | | * | mA |
| Output Impedance (DC) | | 0.05 | | | | * | Ω |
| Short Circuit to Common, Duration ⁽⁷⁾ | | Indefinite | | | | * | |
| ANALOG OUTPUT, I_{OUT} models | | | | | | | |
| Ranges: Bipolar | ± 0.96 | ± 1.0 | ± 1.04 | * | * | * | mA |
| Unipolar | -1.96 | -2.0 | -2.04 | * | * | * | mA |
| Output Impedance: Bipolar | 2.6 | 3.2 | 3.7 | * | * | * | k Ω |
| Unipolar | 4.6 | 6.6 | 8.6 | * | * | * | k Ω |
| Compliance | -2.5 | | +2.5 | * | | * | V |
| REFERENCE VOLTAGE OUTPUT | | | | | | | |
| External Current (constant load) | +6.23 | +6.30 | +6.37 | * | * | * | V |
| Drift vs Temperature | | | ± 20 | | | ± 10 | ppm/°C |
| Output Impedance | | 1 | | | * | | Ω |
| POWER SUPPLY SENSITIVITY | | | | | | | |
| $V_{CC} = \pm 12VDC$ or $\pm 15VDC$ | | ± 0.002 | ± 0.006 | | * | ± 0.004 | % FSR / % V_{CC} |
| POWER SUPPLY REQUIREMENTS | | | | | | | |
| $\pm V_{CC}$ | ± 11.4 | | ± 16.5 | * | | * | VDC |
| Supply Drain (no load): + V_{CC} | | 8 | 12 | * | | * | mA |
| - V_{CC} | | 15 | 20 | * | | * | mA |
| Power Dissipation ($V_{CC} = \pm 15VDC$) | | 345 | 480 | * | | * | mW |
| TEMPERATURE RANGE | | | | | | | |
| Specification | -25 | | +85 | -55 | | +125 | °C |
| Storage | -65 | | +150 | * | | * | °C |

*Specification same as DAC85H.

NOTES: (1) Refer to "Logic Input Compatibility" section. (2) Adjustable to zero with external trim potentiometer. (3) FSR means full scale range and is 20V for $\pm 10V$ range, 10V for $\pm 5V$ range for V_{OUT} models; 2mA for I_{OUT} models. (4) To maintain drift spec, internal feedback resistors must be used. (5) Includes the effects of gain, offset and linearity drift. Gain and offset errors externally adjusted to zero at +25°C. (6) For $\pm V_{CC}$ less than $\pm 12VDC$, limit output current load to $\pm 2.5mA$ to maintain $\pm 10V$ full scale output voltage swing. For output range of $\pm 5V$ or less, the output current is $\pm 5mA$ over entire $\pm V_{CC}$ range. (7) Short circuit current is 40mA, max.

FUNCTIONAL DIAGRAMS AND PIN ASSIGNMENTS

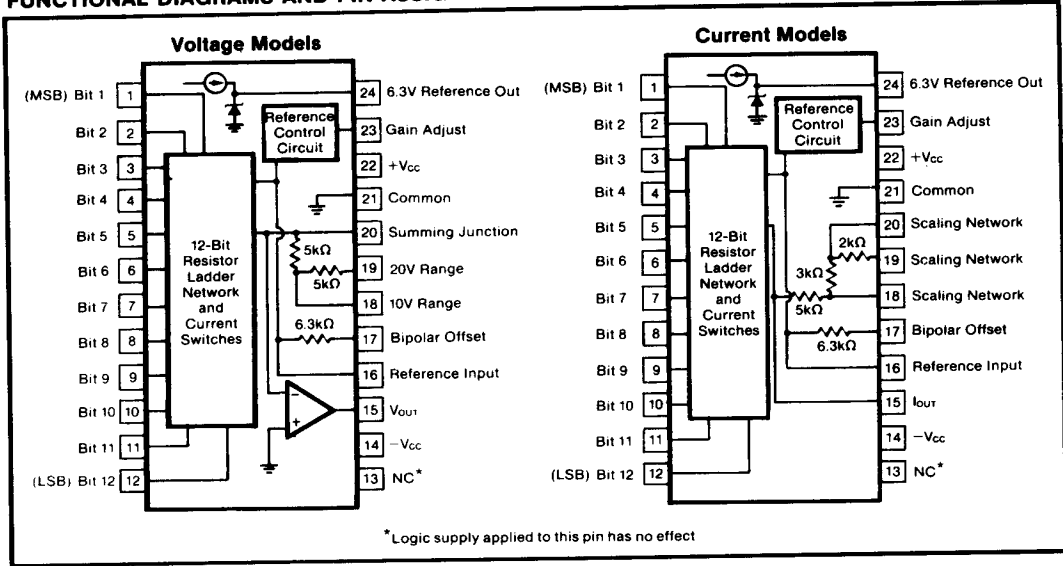

MECHANICAL

PACKAGE (Hermetic DIP)

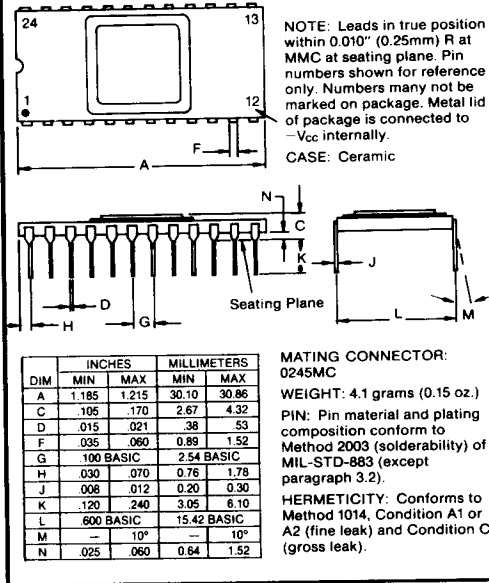

ABSOLUTE MAXIMUM RATINGS

| | |
|-------------------------------------|------------------|
| +V _{cc} to Common | 0V to +18V |
| -V _{cc} to Common | 0V to -18V |
| Digital Data Inputs to Common | -1V to +18V |
| Reference Output to Common | ±V _{cc} |
| Reference Input to Common | ±V _{cc} |
| Bipolar Offset to Common | ±V _{cc} |
| 10V Range R to Common | ±V _{cc} |
| 20V Range R to Common | ±V _{cc} |
| External Voltage to DAC Output | -5V to +5V |
| Max Junction Temperature | 165°C |
| Lead Temperature, Soldering | +300°C, 10s |
| Thermal Resistance, θ _{JA} | 65°C/W |

Stresses above those listed under "Absolute Maximum Ratings" may cause permanent damage to the device. Exposure to absolute maximum conditions for extended periods may affect device reliability.

ORDERING INFORMATION

| Model | Output |
|--------------------------------|---------|
| DAC85H-CBI-I | Current |
| DAC85H-CBI-IBI ⁽¹⁾ | Current |
| DAC85H-CBI-I/QM ⁽²⁾ | Current |
| DAC85H-CBI-V | Voltage |
| DAC85H-CBI-VBI | Voltage |
| DAC85H-CBI-V/QM | Voltage |
| DAC87H-CBI-V | Voltage |
| DAC87H-CBI-VBI | Voltage |
| DAC87H-CBI-V/QM | Voltage |

NOTES: (1) BI indicates burn-in screening option at +125°C for 160h or equivalent. See text for details. (2) QM indicates environmental screening. See text for details.

ENVIRONMENTAL SCREENING

/QM Screening

Burr-Brown /QM models are environmentally-screened versions of our standard industrial products, designed to provide enhanced reliability. The screening, tabulated below, is performed to selected methods of MIL-STD-883. Reference to these methods provides a convenient method of communicating the screening levels and basic procedures employed; it does not imply conformance to any other military standards or to any methods of MIL-STD-883 other than those specified below. Burr-Brown's detailed procedures may vary slightly, model-to-model, from those in MIL-STD-883.

Screening Flow For /QM Models

| Screen | MIL-STD-883 Method | Condition | Comments |
|---|--------------------|-----------|---|
| Internal Visual | 2010 | B | |
| High Temperature Storage (Stabilization Bake) | 1008 | C | +150°C, 24hrs |
| Temperature Cycling | 1010 | C | -65 to +150°C, 10 cycles |
| Burn-in | 1015 | B | +125°C, 160hrs |
| Constant Acceleration | 2001 | E | 30,000 Gs |
| Hermeticity Fine Leak | 1014 | A1 or A2 | 5 × 10 ⁻⁸ atm cc/sec 60psig, 2hrs |
| Gross Leak | 1014 | C | |
| External Visual | 2009 | | |

DISCUSSION OF SPECIFICATIONS

DIGITAL INPUT CODES

The DAC85H Series accepts complementary binary digital input codes. The CBI model may be connected by the user for any one of three complementary codes: CSB, COB, or CTC (see Table I).

TABLE I. Digital Input Codes.

| Digital Input | | Analog Output | | |
|---------------|-----|--|---------------------------------------|---|
| MSB | LSB | CSB Complementary Straight Binary | COB Complemen. Offset Binary | CTC* Complemen. Two's Complement |
| 000000000000 | | +Full Scale | +Full Scale | -1LSB |
| 011111111111 | | +1/2 Full Scale | Zero | -Full Scale |
| 100000000000 | | 1/2 Full Scale -1LSB | -1LSB | +Full Scale |
| 111111111111 | | Zero | -Full Scale | Zero |

*Invert the MSB of the COB code with an external inverter to obtain CTC code.

ACCURACY

Linearity of a D/A converter is the true measure of its performance. The linearity error of the DAC85H Series is specified over its entire temperature range. This means that the analog output will not vary by more than $\pm 1/2LSB$, maximum, from an ideal straight line drawn

between the end points (inputs all "1"s and all "0"s) over the specified temperature range.

Differential linearity error of a D/A converter is the deviation from an ideal 1LSB voltage change from one adjacent output state to the next. A differential linearity error specification of $\pm 1/2LSB$ means that the output voltage step sizes can range from 1/2LSB to 3/2LSB when the input changes from one adjacent input state to the next.

Monotonicity over the specification temperature range is guaranteed in the DAC85H Series to insure that the analog output will increase or remain the same for increasing input digital codes.

DRIFT

Gain Drift is a measure of the change in the full scale range output over temperature expressed in parts per million per °C (ppm/°C). Gain drift is established by: 1) testing the end point differences for each DAC85H Series model at minimum temperature, +25°C and maximum temperature; 2) calculating the gain error with respect to the +25°C value and; 3) dividing by the temperature change. This figure is expressed in ppm/°C and is given in the electrical specifications both with and without internal reference.

Offset drift is a measure of the actual change in output over the specification temperature range with all "1"s on the input. The offset is measured at +25°C, minimum temperature and maximum temperature. The maximum change in Offset is referenced to the Offset at 25°C and is divided by the temperature range. This drift is expressed in parts per million of full scale range per °C (ppm/°C).

SETTLING TIME

Settling time for each DAC85H Series model is the total time (including slew time) required for the output to settle within an error band around its final value after a change in input (see Figure 1).

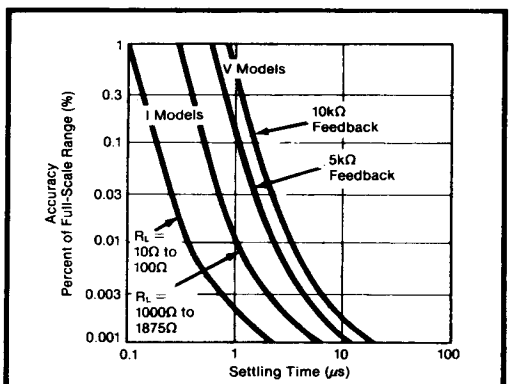

FIGURE 1. Full Scale Range Settling Time vs Accuracy.

Voltage Output Models

Three settling times are specified to $\pm 0.01\%$ of full scale range (FSR); two for maximum full scale range changes of 20V, 10V and one for a 1LSB change. The 1LSB change is measured at the major carry (0111...11 to 1000...00), the point at which the worst case settling time occurs.

Current Output Models

Two settling times are specified to $\pm 0.01\%$ of FSR. Each is given for current models connected with two different resistive loads: 10 Ω to 100 Ω and 1000 Ω to 1875 Ω . Internal resistors are provided for connecting nominal load resistances of approximately 1000 Ω to 1800 Ω for output voltage range of $\pm 1V$ and 0 to $-2V$. See Figure 11.

COMPLIANCE

Compliance voltage is the maximum voltage swing allowed on the current output node in order to maintain specified accuracy. The maximum compliance voltage of all current output models is $\pm 2.5V$. Maximum safe voltage swing permitted without damage to the DAC85H Series is $\pm 5V$.

POWER SUPPLY SENSITIVITY

Power supply sensitivity is a measure of the effect of a power supply change on the D/A converter output. It is defined as a percent of FSR per percent of change in either the positive or negative supplies about the nominal power supply voltages (see Figure 2).

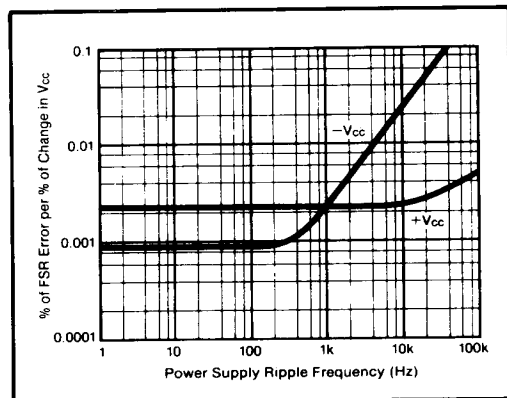

FIGURE 2. Power Supply Rejection vs Power Supply Ripple.

REFERENCE SUPPLY

All DAC85H Series models are supplied with an internal 6.3V reference voltage supply. This voltage (pin 24) has a tolerance of $\pm 1\%$ and must be connected to the Reference Input (pin 16) for specified operation. This reference may be used externally also, but external current drain is limited to 2.5mA.

If a varying load is to be driven, an external buffer amplifier is recommended to drive the load in order to isolate bipolar offset from load variations. Gain and bipolar offset adjustments should be made under constant load conditions.

LOGIC INPUT COMPATIBILITY

DAC85H Series digital inputs are TTL, LSTTL and 4000B, 54/74HC CMOS compatible. The input switching threshold remains at the TTL threshold over the entire supply range.

Logic "0" input current over temperature is low enough to permit driving DAC85H Series directly from outputs of 4000B and 54/74C CMOS devices.

OPERATING INSTRUCTIONS

POWER SUPPLY CONNECTIONS

Connect power supply voltages as shown in Figure 3. For optimum performance and noise rejection, power supply decoupling capacitors should be added as shown. These capacitors (1 μF tantalum) should be located close to the DAC85H Series.

$\pm 12V$ OPERATION

All DAC85H Series models can operate over the entire power supply range of $\pm 11.4V$ to $\pm 16.5V$. Even with supply levels dropping to $\pm 11.4V$, the DAC can swing a full $\pm 10V$ range, provided the load current is limited to $\pm 2.5mA$. With power supplies greater than $\pm 12V$, the DAC output can be loaded up to $\pm 5mA$. For output swing of $\pm 5V$ or less, the output current is $\pm 5mA$, min. over the entire V_{CC} range.

EXTERNAL OFFSET AND GAIN ADJUSTMENT

Offset and gain may be trimmed by installing external Offset and Gain potentiometers. Connect these potentiometers as shown in Figure 3 and adjust as described below. TCR of the potentiometers should be 100ppm/ $^{\circ}C$ or less. The 3.9M Ω and 10M Ω resistors (20% carbon or better) should be located close to the DAC to prevent noise pickup. If it is not convenient to use these high value resistors, an equivalent "T" network, as shown in Figure 4, may be substituted.

Existing applications that are converting to the monolithic DAC85H Series must change the gain trim resistor on pin 23 from 18M Ω to 10M Ω to insure sufficient adjustment range. Pin 23 is a high impedance point and a 0.001 μF to 0.01 μF ceramic capacitor should be connected from this pin to Common (pin 21) to prevent noise pickup. Refer to Figure 5 for relationship of Offset and Gain adjustments to unipolar and bipolar D/A operation.

Offset Adjustment

For unipolar (CSB) configurations, apply the digital input code that should produce zero potential output and adjust the Offset potentiometer for zero output.

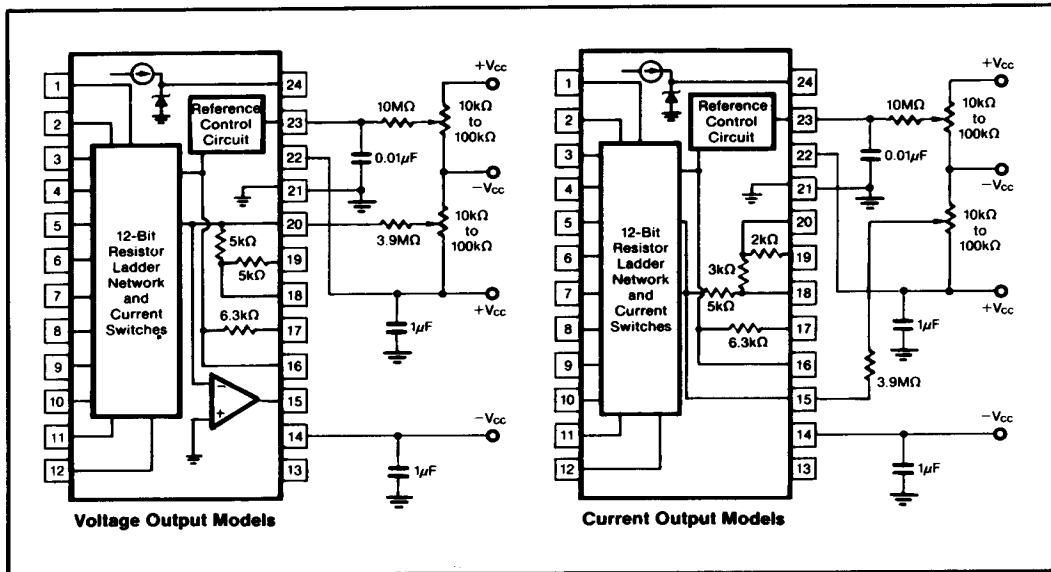

FIGURE 3. Power Supply and External Adjustment Connection Diagrams.

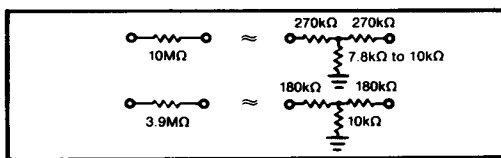

FIGURE 4. Equivalent Resistances.

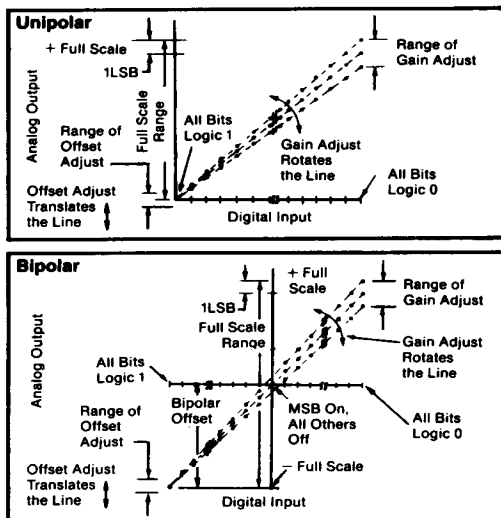

FIGURE 5. Relationship of Offset and Gain Adjustments for a Unipolar and Bipolar D/A Converter.

For bipolar (COB, CTC) configurations, apply the digital input code that should produce the maximum negative output. Example: If the Full Scale Range is connected for 20V, the maximum negative output voltage is $-10V$. See Table II for corresponding codes.

Gain Adjustment

For either unipolar or bipolar configurations, apply the digital input that should give the maximum positive output. Adjust the Gain potentiometer for this positive full scale output. See Table II for positive full scale voltages and currents.

TABLE II. Digital Input/Analog Output.

| DIGITAL INPUT | ANALOG OUTPUT | | | |
|---------------|---------------|-----------|-----------|-----------|
| | VOLTAGE* | | CURRENT | |
| MSB | 0 to +10V | $\pm 10V$ | 0 to -2mA | $\pm 1mA$ |
| LSB | 0 to +10V | $\pm 10V$ | 0 to -2mA | $\pm 1mA$ |
| 0000000000 | +9.9976V | +9.9951V | -1.9995mA | -0.9995mA |
| 0111111111 | +5.0000V | 0.0000V | -1.0000mA | 0.0000mA |
| 1000000000 | +4.9976V | -0.0049V | -0.9995mA | +0.0005mA |
| 1111111111 | 0.0000V | -10.0000V | 0.0000mA | +1.000mA |
| One LSB | 2.44mV | 4.88mV | 0.488μA | 0.488μA |

*To obtain values for other binary ranges:
 0 to +5V range divide 0 to +10V range values by 2.
 $\pm 5V$ range: divide $\pm 10V$ range values by 2.
 $\pm 2.5V$ range: divide $\pm 10V$ range values by 4.

VOLTAGE OUTPUT MODELS

Output Range Connections

Internal scaling resistors provided in the DAC85H Series may be connected to produce bipolar output voltage ranges of $\pm 10V$, $\pm 5V$ or $\pm 2.5V$ or unipolar output voltage ranges of 0 to +5V or 0 to +10V. See Figure 6.

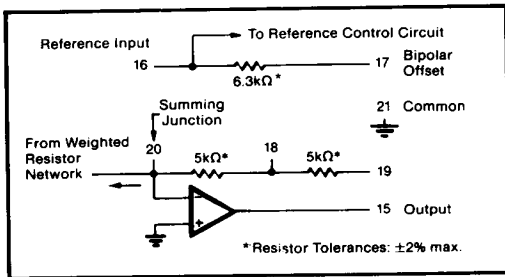

FIGURE 6. Output Amplifier Voltage Range Scaling Circuit.

Gain and offset drift are minimized because of the thermal tracking of the scaling resistors with other internal device components. Connections for various output voltage ranges are shown in Table III. Settling time for a full-scale range change is specified as 4μs for the 20V range and 3μs for the 10V range.

TABLE III. Output Voltage Range Connections for Voltage Models.

| Output Range | Digital Input Codes | Connect Pin 15 to | Connect Pin 17 to | Connect Pin 19 to | Connect Pin 16 to |
|--------------|---------------------|-------------------|-------------------|-------------------|-------------------|
| ±10 | COB or CTC | 19 | 20 | 15 | 24 |
| ±5 | COB or CTC | 18 | 20 | NC | 24 |
| ±2.5V | COB or CTC | 18 | 20 | 20 | 24 |
| 0 to +10V | CSB | 18 | 21 | NC | 24 |
| 0 to +5V | CSB | 18 | 21 | 20 | 24 |

CURRENT OUTPUT MODELS

The resistive scaling network and equivalent output circuit of the current model differ from the voltage model and are shown in Figures 7 and 8.

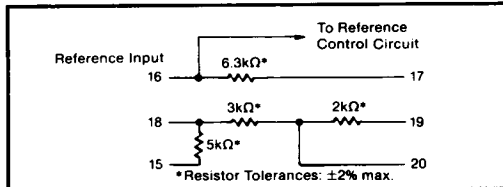

FIGURE 7. Internal Scaling Resistors.

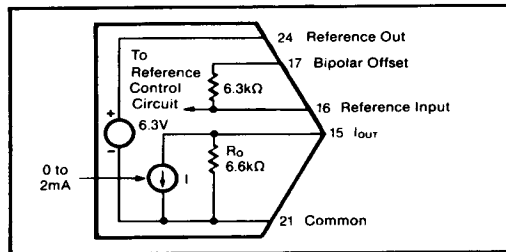

FIGURE 8. Current Output Model Equivalent Output Circuit.

Internal scaling resistors (Figure 7) are provided to scale an external op amp or to configure load resistors for a voltage output. These connections are described in the following sections.

If the internal resistors are not used for voltage scaling, external R_L (or R_F) resistors should have a TCR of ±25ppm/°C or less to minimize drift. This will typically add ±50ppm/°C plus the TCR of R_L (or R_F) to the total drift.

Driving An External Op Amp

The current output model DAC85H will drive the summing junction of an op amp used as a current-to-voltage converter to produce an output voltage. See Figure 9.

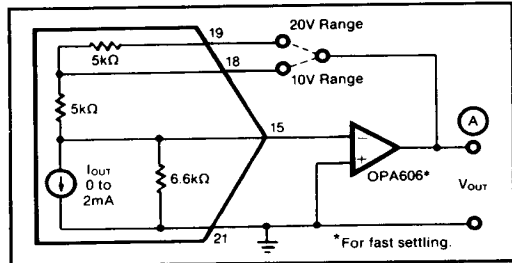

FIGURE 9. External Op Amp—Using Internal Feedback Resistors.

$$V_{OUT} = I_{OUT} \times R_F$$

where I_{OUT} is the DAC85H output current and R_F is the feedback resistor. Using the internal feedback resistors of the current output model DAC85H provides output voltage ranges the same as the voltage model DAC85H. To obtain the desired output voltage range when connecting an external op amp, refer to Table IV.

TABLE IV. Voltage Range of Current Output

| Output Range | Digital Input Codes | Connect (A) to | Connect Pin 17 to | Connect Pin 19 to | Connect Pin 16 to |
|--------------|---------------------|----------------|-------------------|-------------------|-------------------|
| ±10V | COB or CTC | 19 | 15 | (A) | 24 |
| ±5V | COB or CTC | 18 | 15 | NC | 24 |
| ±2.5V | COB or CTC | 18 | 15 | 15 | 24 |
| 0 to +10V | CSB | 18 | 21 | NC | 24 |
| 0 to +5V | CSB | 18 | 21 | 15 | 24 |

Output Larger Than 20V Range

For output voltage ranges larger than ±10V, a high voltage op amp may be employed with an external feedback resistor. Use I_{OUT} values of ±1mA for bipolar voltage ranges and -2mA for unipolar voltage ranges. See Figure 10. Use protection diodes when a high voltage op amp is used.

The feedback resistor, R_F , should have a temperature coefficient as low as possible. Using an external feedback resistor, overall drift of the circuit increases due to the lack of temperature tracking between R_F and the internal scaling resistor network. This will typically add 50ppm/°C plus R_F drift to total drift.

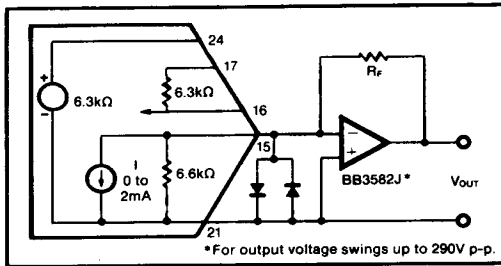

FIGURE 10. External Op Amp—Using External Feedback Resistors.

Driving a Resistive Load Unipolar

A load resistance, $R_L = R_{LI} + R_{LS}$, connected as shown in Figure 11 will generate a voltage range, V_{OUT} , determined by:

$$V_{OUT} = -2mA [(R_L \times R_O) \div (R_L + R_O)]$$

The unipolar output impedance R_O equals $6.6k\Omega$ (typ) and R_{LI} is the internal load resistance of 968Ω (derived by connecting pin 15 to pin 20 and pin 18 to 19). By choosing $R_{LS} = 210\Omega$, $R_L = 1178\Omega$. R_L in parallel with R_O yields $1k\Omega$ total load. This gives an output range of 0 to $-2V$. Since R_O is not exact, initial trimming per Figure 3 may be necessary; also R_{LS} may be trimmed.

BURN-IN SCREENING

Burn-in screening is an option available for the DAC85BH and DAC87BH. Burn-in duration is 160 hours at $+125^\circ C$ ambient temperature (or equivalent combination of time and temperature).

All units are tested after burn-in to ensure that grade specifications are met. To order burn-in, add "BI" to the base model number.

Driving a Resistive Load Bipolar

The equivalent output circuit for a bipolar output voltage range is similar to Figure 11, $R_L = R_{LI} + R_{LS}$. V_{OUT} is determined by:

$$V_{OUT} = \pm 1mA [(R_O \times R_L) \div (R_O + R_L)]$$

By connecting pin 17 to 15, the output current becomes bipolar ($\pm 1mA$) and the output impedance R_O becomes $3.2k\Omega$ ($6.6k\Omega \parallel 6.3k\Omega$). R_{LI} is 1200Ω (derived by connecting pin 15 to 18 and pin 18 to 19). By choosing $R_{LS} = 255\Omega$ (for a bipolar output connect R_{LS} between pin 20 and pin 21), $R_L = 1455\Omega$. R_L in parallel with R_O yields $1k\Omega$ total load. This gives an output range of $\pm 1V$. As indicated above, trimming may be necessary.

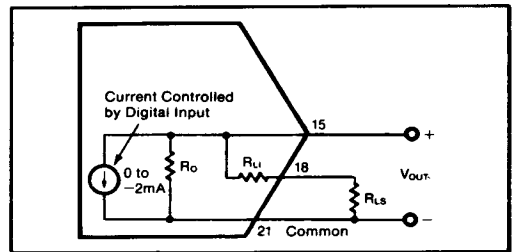

FIGURE 11. Current Output Model Equivalent Circuit Connected for Unipolar Voltage Output with Resistive Load.