

Acer Aspire 1300 Series

Service Guide

Service guide files and updates are available on the ACER/CSD web; for more information, please refer to <http://csd.acer.com.tw>

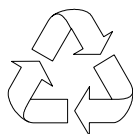

100% Recycled Paper

PART NO.: VD.A0307.001

PRINTED IN TAIWAN

Revision History

Please refer to the table below for the updates made on Aspire 1300 service guide.

Date	Chapter	Updates

Copyright

Copyright © 2002 by Acer Incorporated. All rights reserved. No part of this publication may be reproduced, transmitted, transcribed, stored in a retrieval system, or translated into any language or computer language, in any form or by any means, electronic, mechanical, magnetic, optical, chemical, manual or otherwise, without the prior written permission of Acer Incorporated.

Disclaimer

The information in this guide is subject to change without notice.

Acer Incorporated makes no representations or warranties, either expressed or implied, with respect to the contents hereof and specifically disclaims any warranties of merchantability or fitness for any particular purpose. Any Acer Incorporated software described in this manual is sold or licensed "as is". Should the programs prove defective following their purchase, the buyer (and not Acer Incorporated, its distributor, or its dealer) assumes the entire cost of all necessary servicing, repair, and any incidental or consequential damages resulting from any defect in the software.

Acer is a registered trademark of Acer Corporation.

Intel is a registered trademark of Intel Corporation.

Pentium and Pentium II/III are trademarks of Intel Corporation.

Other brand and product names are trademarks and/or registered trademarks of their respective holders.

Conventions

The following conventions are used in this manual:

SCREEN MESSAGES	Denotes actual messages that appear on screen.
NOTE	Gives bits and pieces of additional information related to the current topic.
WARNING	Alerts you to any damage that might result from doing or not doing specific actions.
CAUTION	Gives precautionary measures to avoid possible hardware or software problems.
IMPORTANT	Reminds you to do specific actions relevant to the accomplishment of procedures.

Preface

Before using this information and the product it supports, please read the following general information.

1. This Service Guide provides you with all technical information relating to the BASIC CONFIGURATION decided for Acer's "global" product offering. To better fit local market requirements and enhance product competitiveness, your regional office MAY have decided to extend the functionality of a machine (e.g. add-on card, modem, or extra memory capability). These LOCALIZED FEATURES will NOT be covered in this generic service guide. In such cases, please contact your regional offices or the responsible personnel/channel to provide you with further technical details.
2. Please note WHEN ORDERING FRU PARTS, that you should check the most up-to-date information available on your regional web or channel. If, for whatever reason, a part number change is made, it will not be noted in the printed Service Guide. For ACER-AUTHORIZED SERVICE PROVIDERS, your Acer office may have a DIFFERENT part number code to those given in the FRU list of this printed Service Guide. You MUST use the list provided by your regional Acer office to order FRU parts for repair and service of customer machines.

Chapter 1	System Specifications	9
	Features	9
	System Block Diagram	11
	Board Layout	12
	Top View	12
	Bottom View	14
	Outlook View	15
	Front View	15
	Left Panel	17
	Right Panel	18
	Rear Panel	19
	Bottom Panel	20
	Indicators	21
	Keyboard	22
	Special keys	22
	Touchpad	25
	Touchpad Basics	25
	Launch Keys	27
	Hardware Specifications and Configurations	28
Chapter 2	System Utilities	37
	BIOS Setup Utility	37
	Navigating the BIOS Setup Utility	37
	Startup	38
	Exit	39
	BIOS Flash Utility	40
	System Diagnostic Diskette	40
Chapter 3	Machine Disassembly and Replacement	41
	General Information	42
	Before You Begin	42
	Disassembly Procedure Flowchart	43
	Removing the Memory/HDD Module	46
	Removing the Keyboard/LCD Module	47
	Disassembling the Main Unit	48
	Disassembling the LCD Module-14.1 Inch	51
	Disassembling the LCD Module-15.1 Inch	52
	Disassembling the External Modules	53
	Disassembling the HDD Module	53
	Disassembling the Floppy Disk Drive Module	53
	Disassembling the Optical Drive Module	53
Chapter 4	Troubleshooting	55
	System Check Procedures	56
	External Diskette Drive Check	56
	External CD-ROM Drive Check	56
	Keyboard or Auxiliary Input Device Check	57
	Memory Check	57
	Power System Check	57
	Touchpad Check	58
	Power-On Self-Test (POST) Error Message	59
	Index of Error Messages	60
	Index of Symptom-to-FRU Error Message	62
	Intermittent Problems	66

Table of Contents

Undetermined Problems	67
Chapter 5 Jumper and Connector Locations	69
Top View	69
Bottom View	70
Chapter 6 FRU (Field Replaceable Unit) List	71
Aspire 1300	82
Appendix A Model Definition and Configuration	82
Main Features	83
Appendix B Test Compatible Components	85
Microsoft Windows XP (Home) Environment Test	86
Appendix C Online Support Information	89
Index	91

System Specifications

Features

This computer was designed with the user in mind. Here are just a few of its many features:

Performance

- Mobile AMD Athlon XP1400+/XP1800+, or higher processor
- VIA ProSavage KN133 (Twister K)+VT8362 & VT8231 chipset
- 2 memory slots supporting 133MHz SDRAM (PC-133), upgradeable to 1GB
- 20GB or higher capacity Enhanced-IDE hard disk
- Microsoft Windows XP operating system

Display

- The 14.1" or 15.0" display panel provides a large viewing area for maximum efficiency and ease-of-use. The thin-film transistor (TFT) liquid crystal display (LCD) supports extended graphics array (XGA) resolution, enabling 16.7 million colors at 1024X768
- Aspire 1300 series notebook computer features an accelerated graphics port (AGP) video system integrated in the VIA S3 Savage 4 KN 133 (Twister K) chipset. This provides a robust solution and enables high quality video output.
- Simultaneous LCD, external monitor or projector display

Multimedia

- Build-in optical drive (CD-ROM, DVD-ROM, or DVD/CD-RW combo drive)
- 14.1" or 15.0" XGA TFT LCD panel
- Built-in stereo speakers
- Audio input and output jacks

Connectivity

- Built-in 10/100 Mbps Ethernet connection
- Built-in 56Kbps fax/data modem
- 2 Universal Serial Bus (USB) ports

Human-centric design and ergonomics

- All-in-one design (incorporating hard drive, optical drive and floppy disk drive)
- Rugged, yet extremely portable, construction
- Stylish appearance
- Full-size keyboard with 4 programmable launch keys
- Comfortable palm rest area with well-positioned touchpad

Expansion

- Upgradeable memory modules and hard disk
- PC card slot enables a range of add-on options

Keyboard and Pointing Device

- 87-(US)/88(Europe)-key Windows keyboard
- Ergonomically-centered touchpad pointing device

I/O Ports

- One PCMCIA slot (type II or type III)
- One RJ-11 modem jack (V.90, 56K)
- One RJ-45 network jack (Ethernet 10/100) mbs
- One DC-in jack
- One parallel port (ECP/EPP compliant)
- One VGA (external monitor) port
- One headphone-out jack (3.5mm minijack)
- One microphone-in jack (3.5mm minijack)
- Two Universal Serial Bus (USB) ports

System Block Diagram

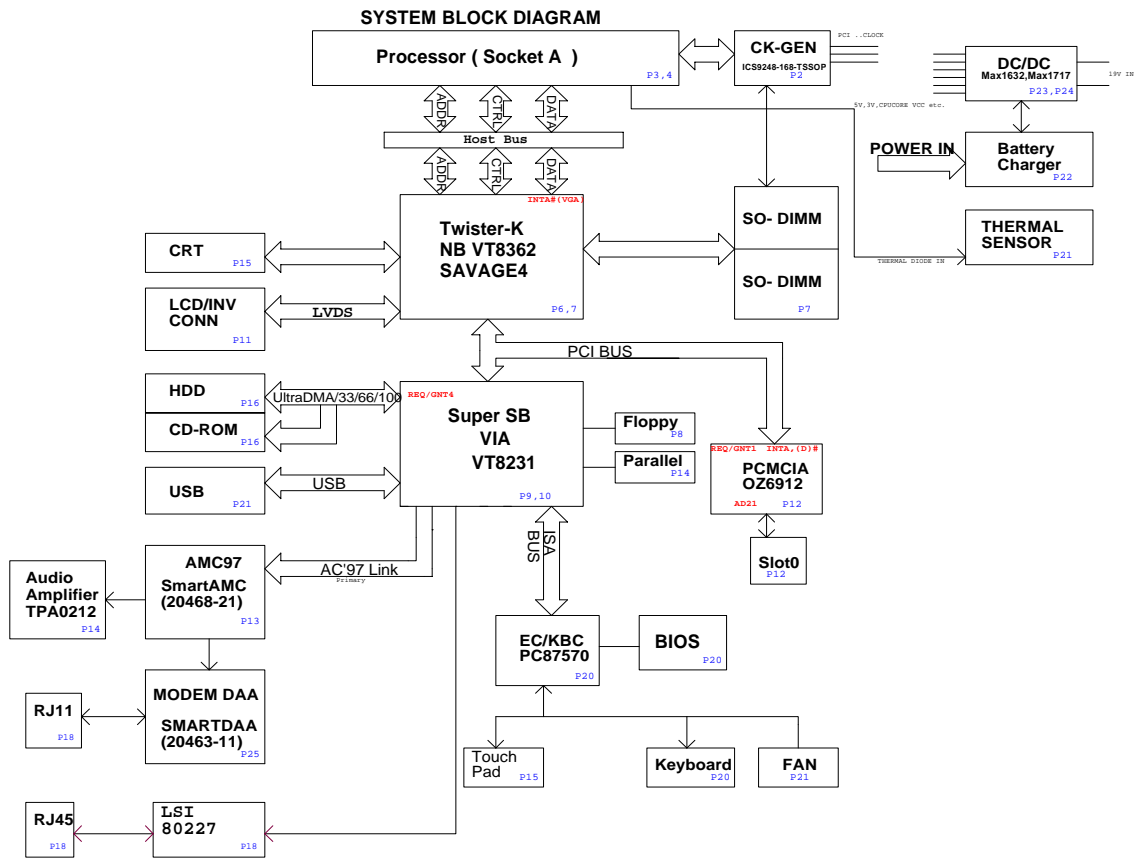

Board Layout

Top View

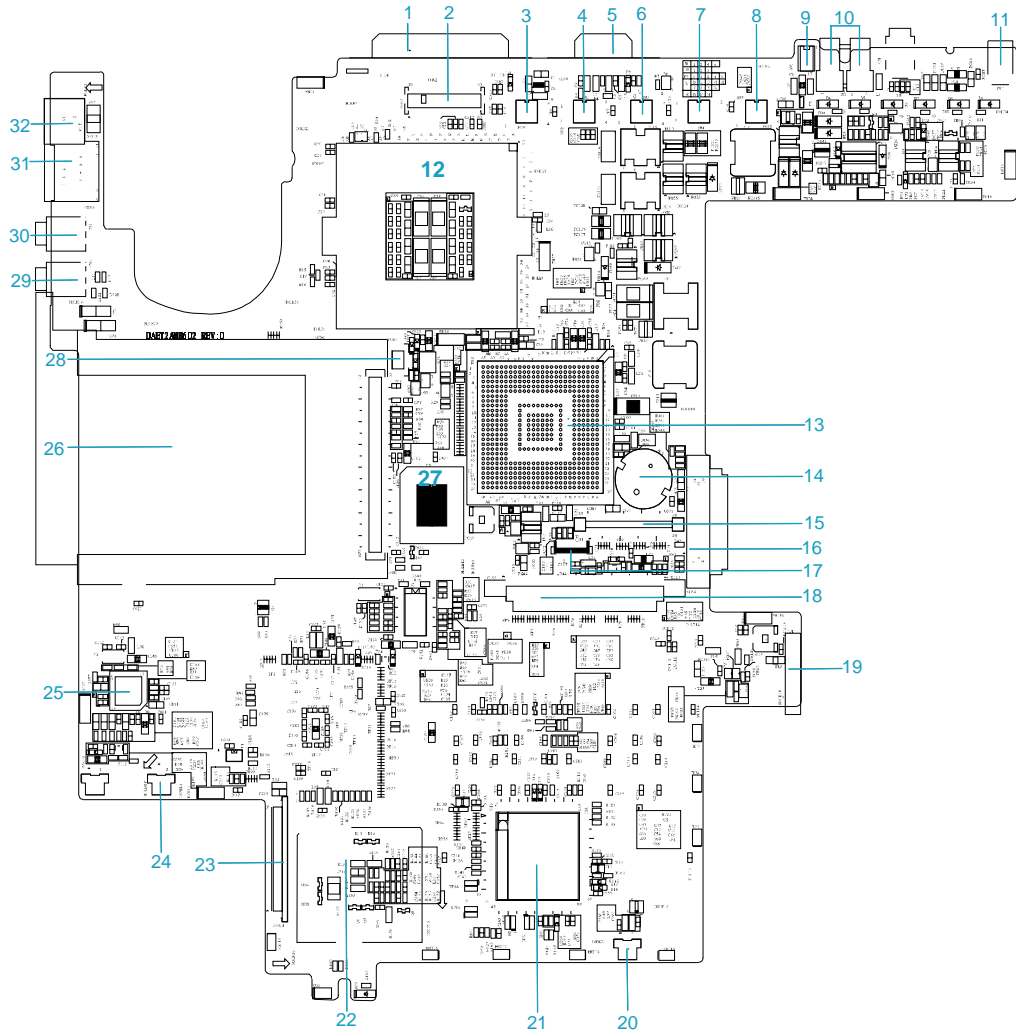

- | | | | |
|----|--------------------------------|----|----------------------------------|
| 1 | Parallel Port | 17 | Touchpad FFC Connector |
| 2 | LCD Cable Connector | 18 | HDD Connector |
| 3 | Power On Switch | 19 | Battery Connector |
| 4 | E-mail launch button | 20 | Right Speaker Connector |
| 5 | VGA Port | 21 | EC/KBC 87570 |
| 6 | Internet launch button | 22 | On Board Modem module |
| 7 | Launch Manager (User Define 1) | 23 | FDD FPC Connector |
| 8 | Launch Manager (User Define 2) | 24 | Left Speaker Connector |
| 9 | Lid closeSwitch | 25 | Audio Decode SmartAMC (20468-21) |
| 10 | USB Portx2 | 26 | Carbus Socket |
| 11 | Adapter Connector | 27 | BIOS Socket |
| 12 | CPU Socket | 28 | FAN connector |

13	North Bridge VT8362	29	Headphone Jack
14	RTC Battery Socket	30	Microphone-in Jack
15	Keyboard FFC connector	31	LAN Connector
16	CD/DVD-ROM Module Connector	32	Modem Connector

Bottom View

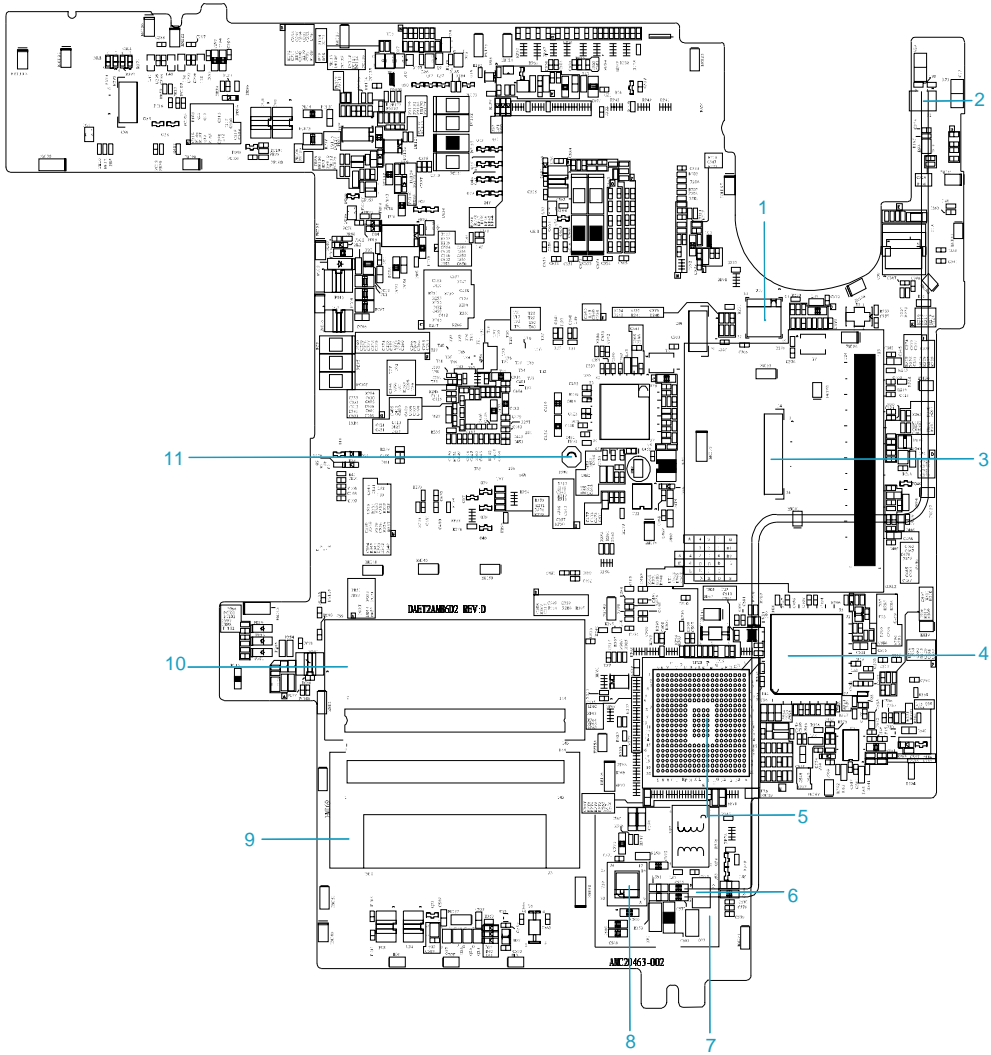

- | | | | |
|---|-----------------------|----|-----------------------|
| 1 | LAN PHY LSI-80227 | 7 | On Board Modem Module |
| 2 | Modem Cable Connector | 8 | Modem DAA SMARTDAA |
| 3 | Debug Port Connector | 9 | DIMM Socket 2 |
| 4 | PCMCIA OZ6912 | 10 | DIMM Socket 1 |
| 5 | South Bridge VT8231 | 11 | System-off Switch |
| 6 | Modem Cable Connector | | |

Outlook View

A general introduction of ports allow you to connect peripheral devices, as you would with a desktop PC.

Front View



#	Item	Description
1	Display	Large liquid crystal display (LCD) provides visual output.
2	Launch keys	4 buttons that can be programmed to start frequently used applications.
3	Power button	Turns the computer on and off.
4	Touchpad	Touch sensitive pad that functions like a computer mouse.
5	Click buttons & scroll key	Right and left buttons that provide the same functions as the buttons on a computer mouse. The scroll key scrolls the contents of a window up and down.
6	Speakers	Left and right speakers deliver stereo audio output.

7	Palm rest	Provides a comfortable platform for your hands when typing on the keyboard.
8	Keyboard	Full-size keyboard for inputting typed data.
9	Status indicators	Light emitting diodes (LED) that show the status of the computer and its componenets.
10	Latch	Locks and releases the lid.

Left Panel



#	Item	Description
1	Modem jack	Connects the built-in fax/data modem to a phone line.
2	Network jack	Connects the computer to an Ethernet 10/100-based network.
3	Microphone-in jack	Connects an external microphone for audio input.
4	Headphone jack	Connects headphones for audio output.
5	PC card eject button	Press the eject button to remove a PC card for the PC card slot.
6	PC card slot	The slot supports a standard Type II or Type III PC card (PCMCIA or CardBus). Note: The connecting pins locate only on the lower slot. Please pay attention to this as you insert the PC Card.
7	Floppy disk drive	Supports a standard 3.5" diskette.
8	Floppy disk eject button	Press the eject button to remove a diskette from the floppy disk drive.

Right Panel



#	Item	Description
1	Optical drive	Depending on your model, the optical drive is one of the following: CD-ROM drive for reading CDs. DVD-ROM drive for reading CDs and DVDs. DVD/CD-RW combo drive for reading CDs and DVDs, and writing to CD-Rs and CD-RWs.
2	Optical drive emergency eject hole	Used to eject an optical disc when the computer is turned off.
3	Optical drive eject button	Press the eject button to remove a disc from the optical drive.
4	Optical disc read indicator	Light emitting diode (LED) that indicates when an optical disc is being read.

Rear Panel



#	Item	Description
1	Kensington lock slot	For attaching a security connector.
2	DC-in jack	Connects the AC adapter.
3	USB ports	2 ports for connecting USB devices.
4	External display port	Connects an external (VGA) display monitor.
5	Parallel port	Connects a parallel device, such as a printer.
6	Ventilation slots	Enable the computer to stay cool. even after prolonged use.

Bottom Panel



#	Item	Description
1	Ventilation slots	Enables the computer to stay cool, even after prolonged use.
2	Battery	The computer's removable battery.
3	Battery release latch	Slide and hold the latch, and then pull the battery to remove it from the unit.
4	Hard disk bay	Removable cover provides access to the computer's hard drive.
5	Memory compartment	Removable cover provides access to the memory slots for upgrading the computer's memory.

Indicators

Your computer provides an array of six indicators located above the keyboard, in addition to two indicators positioned at the front of the palm rest area. These indicators show the status of the computer and its components.



The six indicators located above the keyboard provide the following status information:

#	Description
1	Caps Lock active
2	Num Lock active (Note: the keypad lock must be turned on to use the embedded numeric keypad.)
3	Scroll Lock active
4	Floppy disk drive activity
5	Hard disk drive activity
6	Optical drive activity

The two indicators located at the front of the unit provide the following status information:

#		
1	Battery charge: Green Amber Red Off	the AC adapter is connected and the battery is fully charged. the AC adapter is connected and the battery is charging. the AC adapter is connected and the battery has a fault. the AC adapter is not connected, or the battery is not installed.
2	Power mode: Steady green Flashing green Off	the computer is on (even if the display is turned off). the computer is in standby mode. the computer is turned off, or in hibernation mode.



Keyboard

Special keys

Lock keys

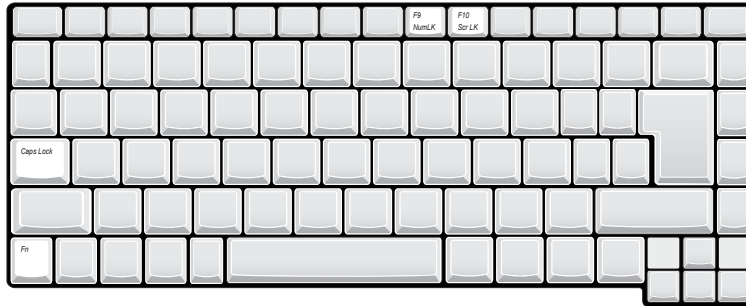
The keyboard features full-size keys with an embedded keypad, separate cursor control keys, two Windows keys, and twelve function keys (hot keys).



Lock Key	Description
Caps Lock	When Caps Lock is on, all alphabetic characters are typed in uppercase. Toggle on and off by pressing the Caps Lock key on the left side of the keyboard.
Num lock	When Num Lock is on, the embedded numeric keyboard can be used. Toggle on and off by pressing the Fn+  keys simultaneously.
Scroll lock	When Scroll Lock is on, the screen toggles up or down one line at a time when the up and down cursor control keys are pressed. Note: Scroll Lock doesn't work in all applications. Toggle on and off by pressing the Fn +  keys simultaneously.

Embedded Keypad

The embedded keypad functions like a desktop numeric keypad. It is indicated by small blue numbers and on the applicable keys.



To use the the embedded numeric keys, toggle the Num Lock on by pressing the Fn +  keys simultaneously. With the embedded keypad turned on, the following actions are possible:

Desired Access	Num Lock On	Num Lock On
Number keys on embedded keypad	Type numbers using embedded keypad in the normal way.	
Cursor-control keys on embedded keypad	Hold down the SHIFT key while using the cursor keys on the embedded keypad.	Hold Fn key while using cursor-control keys.
Main keyboard keys	Hold down the Fn key while typing letters using the embedded keypad keys. Simultaneously press the SHIFT key for capital letters.	Type letters in the normal way.

Windows Keys

The keyboard has two keys that perform Windows-specific functions.



Key	Description
Windows logo key	Pressed alone, this key has the same effect as clicking on the Windows Start button; it launches the Start menu. It can also be used with other keys to provide a variety of functions: + Tab (Activates the next Taskbar button) + E (Opens the My Computer window) + F1 (opens Help and Support) + F (opens the Find: All Files dialog box) + M (minimizes all windows) SHIFT + Windows logo key + M (undoes the minimize all windows action) + R (opens the Run dialog box)
Application key	This key has the same effect as clicking the right mouse button; it opens the application's context menu.

Hotkeys

Using the Fn key with another key creates a hot key, providing a quick and convenient method for controlling various functions.

To use a hot key, first hold down the Fn key. Next, press the second key in combination. Finally, release both keys.



Hot Key	Function
Fn +	Decreases the display panel brightness.
Fn +	Increases the display panel brightness.
Fn +	Toggles the display setting between (1) the computer's LCD panel, (2) an external display device connected to the external display port, and (3) simultaneous display on the computer's LCD panle and an external display device.
Fn +	Toggles Num Lock on and off. (Please see "Special keys".)
Fn +	Toggles the keyboard's Scroll Lock on and off. (Please see "Special keys".)
Fn +	Toggle the sound on and off. (Mute.)
Fn +	Increases the sound volume. (Doesn't work for an external keyboard.)
Fn +	Decreases the sound volume. (Doesn't work for an external keyboard.)

NOTE: When activating hotkeys, press and hold the **Fn** key before pressing the other key in the hotkey combination.

Keyboard Ergonomics

The wide palm rest area provides a comfortable platform for your hands when typing on the keyboard. The ergonomic design enables you to adopt a relaxed, yet very efficient, typing style.

Touchpad

The built-in touchpad is a PS/2-compatible pointing device that senses movement on its surface. This cursor responds to your finger movements on the touchpad. In addition, the two click buttons provide the same functionality as a computer mouse, while the scroll key enables easy up and down scrolling in documents and web pages.

The touchpad is located in the middle of the palm rest area, providing maximum comfort and efficiency.



Touchpad Basics

Use the touchpad as follows:

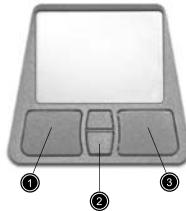

- Slide your finger over the surface of the touchpad to control the movement of the cursor. Tap the touchpad to perform selection and execution functions.
- Press the left (1) and right (3) buttons to perform selection and execution functions, just as you would use the buttons on a computer mouse.
- Use the scroll key (2) to scroll through long documents and web pages. Press the top of the key to scroll up, and the bottom to scroll down.

Function	Left Button	Righ Button	Tap
Execute	Click twice quickly		Tap twice (at the same speed as double-clicking the mouse button)
Select	Click once		Tap once
Drag	Click and hold. Then slide your finger across the touchpad to drag the cursor over the selection.		Tap twice quickly. On the second tap, slide your finger across the touchpad to drag the cursor over the selection.
Access context menu		Click once	

NOTE: Keep your fingers, as well as the surface of the touchpad dry and clean. The touchpad is sensitive to your finger movements: the lighter the touch, the better the response. Tapping hard will not increase the touchpad's responsiveness.

Launch Keys

Located at the top of the keyboard are four buttons. These buttons are called launch keys. They are designated as key 1, key 2, key 3 and key 4. By default, key 1 is used to launch the email application and key 2 is used to launch the Internet browser. Keys 3 and 4 start the Launch Manager application. All four launch keys can be set by the user.

To see the launch keys, run the Acer Launch Manger.



#	Description
Email	Launches your email application.
Web browser	Launches your Internet browser
P1	User-programmable
P2	User-programmable

Hardware Specifications and Configurations

Processor

Item	Specification
CPU type	AMD Athlon XP 1400+ (1.2G) / 1600+ (1.4G) / 1800+ (1.5G) 35W
CPU package	OPGA
CPU core voltage	1.2V/1.45V

BIOS

Item	Specification
BIOS vendor	Acer
BIOS Version	1.0
BIOS ROM type	Flash ROM
BIOS ROM size	512KB
BIOS package	TSOP
Supported protocols	ACPI 1.0b, APM 1.2, PC Card 95, SM BIOS 2.3, EPP/IEEE 1284, ECP/IEEE 1284 1.7 & 1.9, PCI 2.2, PnP 1.0a, DMI 2.0, USB, VESA VGA BIOS, DDC-2B, CD-ROM bootable, Windows keyboard Microsoft Simple Boot Flag
BIOS password control	Set by setup manual

Second Level Cache

Item	Specification
Cache controller	Built-in CPU
Cache size	256KB
1st level cache control	Always enabled
2st level cache control	Always enabled
Cache scheme control	Fixed in write-back

System Memory

Item	Specification
Memory controller	VIA VT8362
Onboard memory size	0MB
DIMM socket number	2 sockets (4 banks)
Supports memory size per socket	512MB
Supports maximum memory size	1024MB
Supports DIMM type	Synchronous DRAM
Supports DIMM Speed	133 MHz
Supports DIMM voltage	3.3V
Supports DIMM package	144-pin soDIMM
Memory module combinations	You can install memory modules in any combinations as long as they match the above specifications.

Memory Combinations

Slot 1	Slot 2	Total Memory
0MB	64MB	64 MB
64MB	0MB	64 MB
0MB	128MB	128 MB
64MB	64MB	128 MB
128MB	0MB	128 MB
64MB	128MB	192MB
128MB	64MB	192MB
128MB	128MB	256MB
256MB	64MB	320MB
64MB	256MB	320MB
256MB	128MB	384MB
128MB	256MB	384MB
256MB	256MB	512MB
512MB	512MB	1024MB
512MB	0MB	512MB
0MB	512MB	512MB

Above table lists some system memory configurations. You may combine DIMMs with various capacities to form other combinations..

LAN Interface

Item	Specification
Chipset	VIA Chipset internal +LSI 80227
Supports LAN protocol	10/100 Mbps
LAN connector type	RJ45
LAN connector location	Left side

Modem Interface

Item	Specification
Chipset	CONEXANT soft modem (on board) 20463-11
Fax modem data baud rate (bps)	14.4K
Data modem data baud rate (bps)	56K
Supports modem protocol	V.90 MDC
Modem connector type	RJ11
Modem connector location	Left side

Floppy Disk Drive Interface

Item	Specification		
Vendor & model name	Panasonic JU-226A 243FC		
Floppy Disk Specifications			
Media recognition	2DD (720KB)	2HD (1.2MB, 3-mode)	2HD (1.44MB)
Sectors/track	9	15	18
Tracks	80	80	80
Rotational speed (RPM)	300	360	300
Read/write heads	2		
Encoding method	MFM/FM		

Floppy Disk Drive Interface

Item	Specification
Power Requirement	
Input Voltage (V)	+5V +/- 10%

Hard Disk Drive Interface

Item	Specification	
Vendor & Model Name	TOSHIBA 20G(MK2018GAP), TITAN	IBM 20G(IC25N020ATCS04-0), 07N8325, CASCADE
Capacity (MB)	20000	20000
Bytes per sector	512	512
Data heads	3	3
Drive Format		
Disks	2	2
Spindle speed (RPM)	4200 RPM	4200 RPM
Performance Specifications		
Buffer size	2048KB	2048KB
Interface	ATA-5	ATA-5
Max. media transfer rate (disk-buffer, Mbytes/s)	216	216
Data transfer rate (host-buffer, Mbytes/s)	100 MB/Sec. Ultra DMA mode-5	100 MB/Sec. Ultra DMA mode-5
DC Power Requirements		
Voltage tolerance	5V(DC) +/- 5%	5V(DC) +/- 5%

DVD-ROM Interface

Item	Specification	
Vendor & model name	DVD-ROM 8X QSI SDR-083	
Performance Specification	With CD Diskette	With DVD Diskette
Transfer rate (KB/sec)	Sustained: Max 3.6Mbytes/sec	Sustained: Max 10.8Mbytes/sec
Data Buffer Capacity	128 KBytes	
Interface	IDE/ATAPI	
Applicable disc format	DVD: DVD-5, DVD-9, DVD-10, DVD-R (3.95G) CD: CD-Audio, CD-ROM (mode1 and mode 2), CD-ROM XA(mode 2 form 1 and form 2), CD-I (mode 2, form 1 and form 2), CD-I Ready, CD-I Bridge CD-WO, CD-RW, Photo CD, Video CD, Enhanced Music CD, CD-TEXT	
Loading mechanism	Soft eject (with emergency eject hole)	
Power Requirement		
Input Voltage	+5 V +/- 5 %	

Audio Interface

Item	Specification
Audio Controller	Conexant CX 20468-21
Audio onboard or optional	Built-in
Mono or Stereo	Stereo
Resolution	20 bit stereo Digital to analog converter 18 bit stereo Analog to Digital converter
Compatibility	Microsoft PC98/PC99, AC97 2.1
Mixed sound source	Line-in, CD, Video, AUX
Voice channel	8/16-bit, mono/stereo
Sampling rate	44.1 KHz
Internal microphone	No
Internal speaker / Quantity	Yes
Supports PnP DMA channel	DMA channel 0 DMA channel 1
Supports PnP IRQ	IRQ3, IRQ5, IRQ7, IRQ9, IRQ10, IRQ11

Video Interface

Item	Specification
Chip vendor	VIA
Chip name	S3 Savage 4 integrated in VT8362
Supports ZV (Zoomed Video) port	No
Graph interface	4X AGP (Accelerated Graphics Port) bus
Maximum resolution (LCD)	1024X768
Maximum resolution (CRT)	1024X768

Video Memory

Item	Resolution	Specification
Fixed or upgradeable		Fixed
Video memory size		16.0MB/32.0MB/8M

Parallel Port

Item	Specification
Parallel port controller	VIA VT8231
Number of parallel port	1
Location	Rear side
Connector type	25-pin D-type connector, in female type
Parallel port function control	Enable/Disable by BIOS Setup
Supports ECP/EPP/Bi-directional (PS/2 compatible)	Yes (set by BIOS setup)
Optional ECP DMA channel (in BIOS Setup)	DMA channel 1 and 3
Optional parallel port I/O address (in BIOS Setup)	3BCh, 278h, 378h
Optional parallel port IRQ (in BIOS Setup)	IRQ7, IRQ5

USB Port

Item	Specification
USB Compliancy Level	1.1
OHCI	USB 1.1
Number of USB port	2
Location	Right panel
Serial port function control	Enable/Disable by BIOS Setup

PCMCIA Port

Item	Specification
PCMCIA controller	OZ 6912
Supports card type	Type-III/II
Number of slots	One type-III
Access location	Left side
Supports ZV (Zoomed Video) port	No ZV support
Supports 32 bit CardBus	Yes (IRQ11)

System Board Major Chips

Item	Controller
System core logic	VIA TwisterK
Super I/O controller	Chipset VT 8231 internal
Audio controller	CONEXANT CX20468-21
Video controller	VIA TwisterK internal S3 Graphics
Hard disk drive controller	VT8231
Keyboard controller	NS87570
RTC	VIA TwisterK VT8362/VT8231

Keyboard

Item	Specification
Keyboard controller	NS 87570
Keyboard vendor & model name	NS
Total number of keypads	84/85-key
Windows 95 keys	Yes
Internal & external keyboard work simultaneously	Yes

Battery

Item	Specification
Vendor & model name	Sanyo
Battery Type	Li-ion/ Ni-MH
Pack capacity	4000mAH
Cell voltage	V/cell
Number of battery cell	8
Package configuration	2 cells in series, 4 series in parallel

Battery

Item	Specification
Package voltage	Li-ion 14.8V/ Ni-MH 9.6V

DCAC LCD inverter

Item	Specification		
Vendor & model name	Quanta 3HYA1 IV0008		
Input voltage (V)	8(min.)	-	20(max.)
Input current (mA)	-	-	520(max.)
Output voltage (Vrms, no load)	-	660(typ.)	-
Output voltage frequency (kHz)	52(min.)	58(typ.)	64(max.)
Output Current/Lamp	Iout(Min.)	2.5mA/2.8mA	Vadj=0V
	Iout(Max.)	6.3mA/6.9mA	Vadj=3.2V

NOTE: DC-AC inverter is used to generate very high AC voltage, the support to LCD CCFT backlight user, and is also responsible for the control of LCD brightness. Avoid touching the DC-AC inverter area while the system is turned on.

LCD

Item	Specification	
Vendor & model name	QDI QD141X1LH03 Samsung LTN141X8L04 AU B141XN04	LG LP150X2-A2M1/LP150X2-A296 Sharp LP150X1 LH82 AU B150XN01
Mechanical Specifications		
LCD display area (diagonal, inch)	14.1	15.0
Display technology	TFT	TFT
Resolution	XGA (1024X768)	XGA (1024x768)
Supports colors	262K	262K
Optical Specification		
Brightness control	keyboard hotkey	keyboard hotkey
Contrast control	No	No
Suspend/Standby control	Yes	Yes
Electrical Specification		
Supply voltage for LCD display (V)	3.3	3.3
Supply voltage for LCD backlight (Vrms)	690	690

AC Adapter

Item	Specification
Vendor & model name	Delta 75W ADP-75FB B(WPFC) 3P Lite-on 75W PA 1750-02Z(WPFC) 3P

AC Adapter

Item	Specification
Input Requirements	
Maximum input current (A, @90Vac, full load)	2.25A @ 90Vac 1.125A @ 180Vac
Nominal frequency (Hz)	47 - 63
Frequency variation range (Hz)	47 - 63
Nominal voltages (Vrms)	100- 240
Inrush current	The maximum inrush current will be less than 50A and 100A when the adapter is connected to 115Vac(60Hz) and 230Vac(50Hz) respectively.
Efficiency	It should provide an efficiency of 83% minimum, when measured at maximum load under 115V(60Hz).
Output Ratings	
DC output voltage	+18.8V~20.0V including the effects of line voltage variation, load current, ripple and noise
Noise + Ripple	400mvp-p (20MHz bandwidth) for resistor load
Output current	0~4A
Input rated voltage	100/240V
Input current	2.25A@90Vac for Delta/ 1.125@180Vac for Lite-On
Dynamic Output Characteristics	
Turn-on delay time	3 sec.
Hold up time	4 ms min. (115 Vac, input full load)
Over Voltage Protection (OVP)	29 V
Short circuit protection	Output can be shorted without damage
Electrostatic discharge (ESD)	15kV (at air discharge) 8kV (at contact discharge)
Dielectric Withstand Voltage	
Primary to secondary	3000Vac (4242Vdc) 10mA for 1 second
Leakage current	100uA max (240Vac, 60Hz)
Regulatory Requirements	Internal filter meets; 1. FCC class B requirements. 2. VDE 243/1991 class B requirements. 3. CISPR 22 Class B requirements. 3. VCCI class II requirements.

Power Management

Power Saving Mode	Phenomenon
<p>Standby Mode</p> <p>Waiting time specified by the System Standby value or the operating system elapses without any system activity.</p> <p>Or</p> <p>When the computer is about to enter Hibernation mode (e.g. during a battery-low condition), but the Hibernation file is invalid or not present.</p>	The Sleep indicator lights up
<p>Hibernation Mode</p> <p>When customized functions for power management are set to Hibernation and the corresponding action is taken.</p>	All power shuts off

Power Management

Power Saving Mode	Phenomenon
Display Standby Mode Keyboard, built-in touchpad, and an external PS/2 pointing device are idle for a specified period.	The display shuts off
Hard Disk Standby Mode Hard disk is idle within a specified period of time	Hard disk drive is in standby mode. (spindle turned-off)

Environmental Requirements

Item	Specification
Temperature	
Operating	0~+40 °C
Non-operating	-20~+60 °C (unpacked)
Non-operating	Non (storage package)
Humidity	
Operating	0% to 90% RH, non-condensing
Non-operating	20% to 90% RH, non-condensing (unpacked)
Non-operating	Non (storage package)
Vibration	
Operating (unpacked)	5~500Hz: 1.0Grms (random)
Non-operating (unpacked)	5~500Hz: 2.16Grms (random)
Non-operating (packed)	5~500Hz: 2.16Grms (random)

Mechanical Specification

Item	Specification
Dimensions	320 (W) x 262 (D) x 34 (H) for 14.1 inch model 330 (W) x 267 (D) x 35 (H) for 15.0 inch model
Weight	2.9Kg (6.4 lbs) for 14.1 inch model; 3.1KG (6.8 lbs) for 15.0 inch model
I/O Ports	2 USB port, 1VGA (external monitor) port, 1 Microphone in jack, 1 Headphone out jack, 1 RJ-11 jack for modem, 1 RJ-45 jack for Ethernet, 1 PCMCIA (Type II or Type III) slot, 1 Parallel port (ECP/EPP compliant), 1DC-in jack for AC adapter
Drive Bays	One
Material	Plastic
Indicators	Power Mode LED, Battery Charge, Caps Lock, Num Lock, Scroll Lock, FDD activity, HDD activity, ODD activity
Switch	Power

Memory Address Map

Memory Address	Size	Function
00100000h-000F0000h	512 KB	System BIOS
000CD000h-000C0000h		VGA BIOS
000C0000h-000A0000h	128 KB	Video memory (VRAM)
000A0000h-00000000h	640KB	Conventional memory

I/O Address Map

I/O Address	Function
000-00F	DMA controller-1
020-021	Interrupt controller-1

I/O Address Map

I/O Address	Function
040-043	Timer 1
060, 064	Keyboard controller 87570 chip select
061	System speaker
040B	DMA controller-1
061	System speaker
070-073	Real-time clock and NMI mask
080-08F	DMA page register
0A0-0A1	Interrupt controller-2
0C0-0DF	DMA controller-2
0F0-0FF	Numeric data processor
66, 62	Power management controller
170-177	2nd EIDE device (CD-ROM) select
1F0-1F7	1st EIDE device (hard drive) select
378, 37F	Parallel port 1
3B0-3BB 3C0-3DF	Video Controller
3F0h-3F7	Standard Floppy Disk Controller
3F0-3F7	Floppy disk controller
480-48F, 4D6	DMA controller-1
CF8-CFF	PCI configuration register

IRQ Assignment Map

Interrupt Channel	Function(Hardware)
IRQ00	System timer
IRQ01	Keyboard
IRQ06	Floppy
IRQ08	CMOS/RTC
IRQ09	SCI IRQ used by ACPI bus
IRQ10	Audio, Modem,
IRQ11	USB, CardBus controller, LAN
IRQ12	Alps pointing device
IRQ13	Numeric data processor
IRQ14	1st EIDE device (hard disk)
IRQ15	2nd EIDE device (CD-ROM drive)

DMA Channel Assignment

DMA Channel	Function(Hardware)
DRQ0	Reserved
DRQ1	Reserved
DRQ2	Floppy
DRQ3	ECP printer port (LPT1)
DRQ4	DMA controller
DRQ5	Reserved
DRQ6	Reserved
DRQ7	Reserved

System Utilities

BIOS Setup Utility

The BIOS Setup Utility is a hardware configuration program built into your computer's BIOS (Basic Input/Output System).

Your computer is already properly configured and optimized, and you do not need to run this utility. However, if you encounter configuration problems, you may need to run Setup. Please also refer to Chapter 4 Troubleshooting when problem arises.

To activate the BIOS Utility, press **F2** during POST.

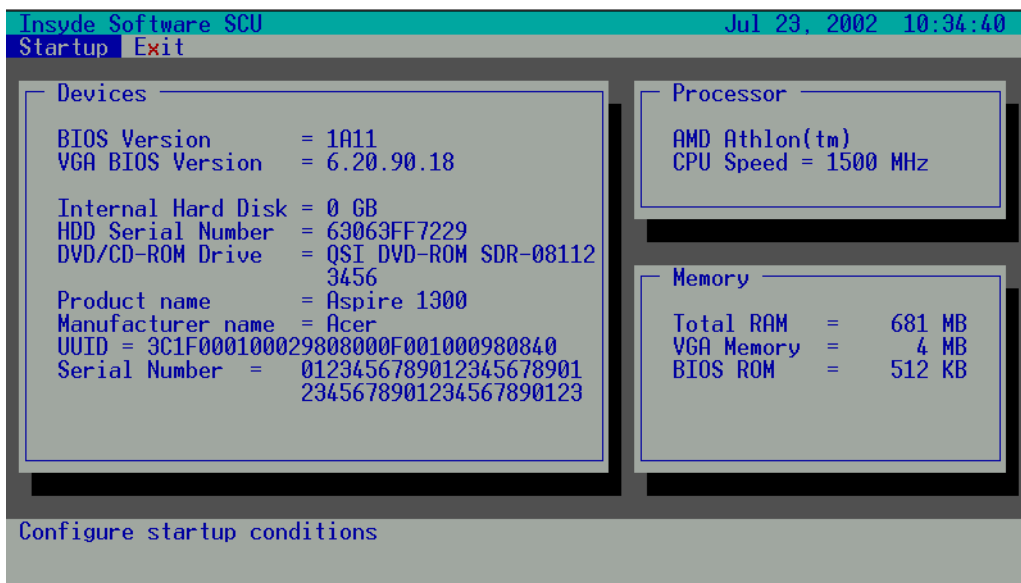



Navigating the BIOS Setup Utility

There are two menu options: Startup and Exit

Follow these instructions:

- To choose a menu option, use the cursor left/right keys (**←** **→**).
- To choose a parameter, use the cursor up/down keys (**↑** **↓**).
- Use **<Tab>** key to select a control. Then press **<OK>** button or **ENTER** key to accept entries.
- To change the value of a parameter, please follow the directions on each screen. If you like to assign the boot device, please go to Boot Device then use the cursor up/down keys (**↑** **↓**) to select a boot device.

Startup

The Startup screen displays a summary of your computer hardware information, and also includes basic setup parameters. After you enter BIOS, you will first see the system information on the first page, then you can use the cursor up/down keys ( ) to select the parameter you like to change.

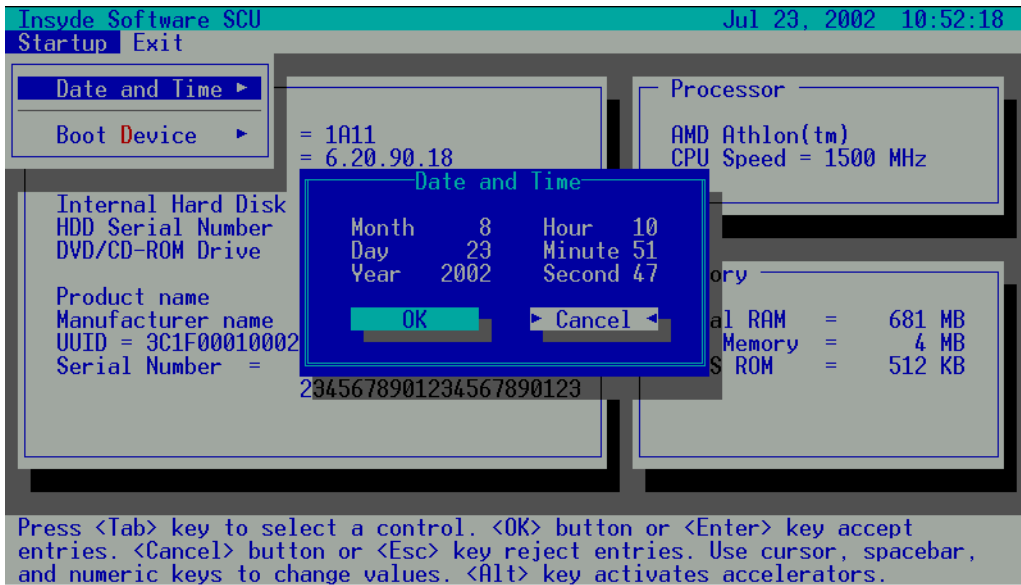

NOTE: The screen above is for reference only. Actual values may differ.

Parameter	Description
Date and Time	Sets the system date and time. Please use <Tab> key going to the item you like to change.
Boot Device	Sets the boot device of the system.

The items in this screen are important and vital information about your computer. If you experience computer problems and need to contact technical support, this data helps our service personnel know more about your computer.

Exit

The Exit screen contains parameters that help safeguard and protect your computer from unauthorized use.



The table below describes the parameters in this screen.

Parameter	Description
Save and Reboot	Saves changes made and reboot the system.
Exit (No Save)	Discards changes made and exits the BIOS Setup Utility.
Default Settings	Loads default settings for all parameters.

BIOS Flash Utility

The BIOS flash memory update is required for the following conditions:

- New versions of system programs
- New features or options
- Restore a BIOS when it becomes corrupted.

Use the Phlash utility to update the system BIOS flash ROM.

NOTE: If you do not have a crisis recovery diskette at hand, then you should create a **Crisis Recovery Diskette** before you use the Flash utility.

NOTE: Do not install memory-related drivers (XMS, EMS, DPMI) when you use the Flash.

NOTE: Please use the AC adaptor power supply when you run the Flash utility. If the battery pack does not contain enough power to finish BIOS flash, you may not boot the system because the BIOS is not completely loaded.

Fellow the steps below to run Flash utility.

1. Prepare a bootable diskette.
2. Copy the Flash utilities to the bootable diskette.
3. Then boot the system from the bootable diskette. The Flash utility has auto-execution function.

System Diagnostic Diskette

IMPORTANT: ¹The diagnostics program we use for Aspire 1300 is not exactly the same as PQA (Product Quality Assurance), the diagnostic program we used to employ in other model. The system diagnostic utilities is provided by Acer Headquarters. You can utilize it as a basic diagnostic tool. To get this program, find it in the Aspire 1300- service CD kit. To better fit local service requirements, your regional office MAY have other diagnostic program. Please contact your regional offices or the responsible personnel/channel to provide you with further technical details. The diagnostic program contains a readme file. Please read the readme file as you run the diagnostic program.

NOTE: For ASSY Function Test Procedure, please prepare the following items for system components test: DIO loopback, SYS_card (Card Bus), AC-adaptor, keyboard, and feather.

Please follow the directions below to create a diagnostic diskette.

Prepare a bootable diskette in advance. Then extract Aspire 1300 zip file to the bootable diskette. When the pop-out message asks you if you like to replace file: command.com with comand.com, please click "No". Next, the pop-out message will ask you if you like to replace file: config.sys with config.sys, click "Yes". Then the pop-out window will display the last message asking you if you like to replace file: AUTOEXEC.BAT with the file AUTOEXEC.BAT. Please click "Yes". After you create the diagnostic diskette, you can boot the system from the bootable diskette.

¹ New added description. Please pay attention to it.

Machine Disassembly and Replacement

This chapter contains step-by-step procedures on how to disassemble the notebook computer for maintenance and troubleshooting.

To disassemble the computer, you need the following tools:

- Wrist grounding strap and conductive mat for preventing electrostatic discharge
- small Philips screwdriver
- flat head screwdriver
- Philips screwdriver
- nut screwdriver
- tweezers

NOTE: The screws for the different components vary in size. During the disassembly process, group the screws with the corresponding components to avoid mismatch when putting back the components. When you remove the stripe cover, please be careful not to scrape the cover.

General Information

Before You Begin

Before proceeding with the disassembly procedure, make sure that you do the following:

1. Turn off the power to the system and all peripherals.
2. Unplug the AC adapter and all power and signal cables from the system.
3. Remove the battery pack.

Disassembly Procedure Flowchart

The flowchart on the succeeding page gives you a graphic representation on the entire disassembly sequence and instructs you on the components that need to be removed during servicing. For example, if you want to remove the system board, you must first remove the keyboard, then disassemble the inside assembly frame in that order.

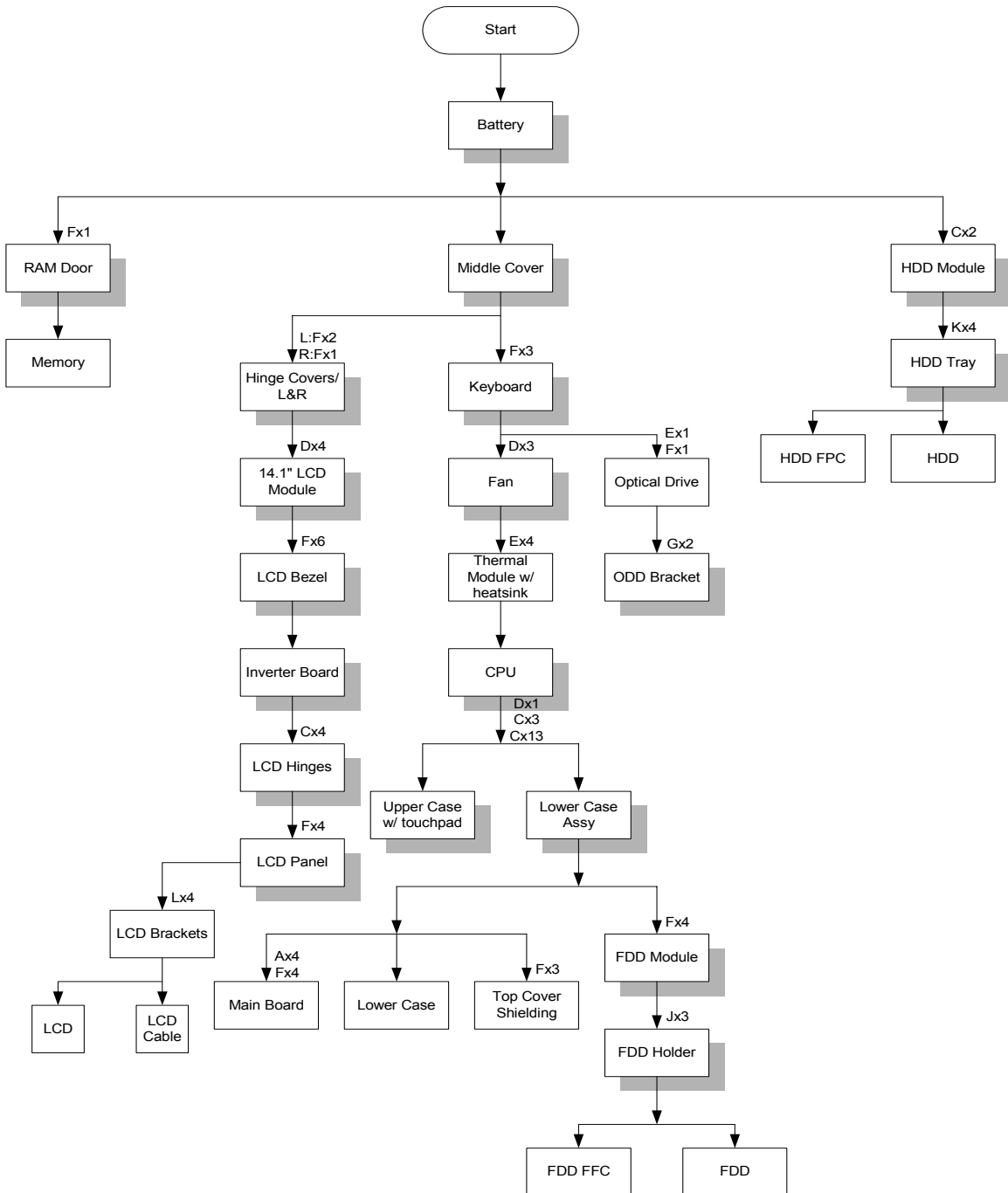

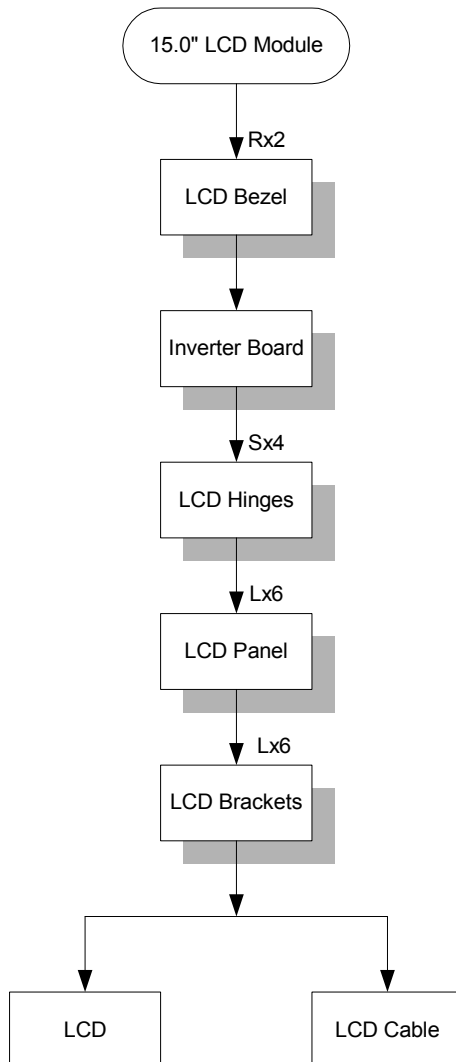

Screw List

Item	Description
A	Screw MBEA1001012 (Screw Nut-I/O)
C	Screw MM250501L64 (MM2.5X5.0)
D	Screw MM25060PC15 (MM2.5X6.0-P)
E	Screw MM200401CI8 (MM2.0X4.0NYLOK)
F	Screw MM250401243 (MM2.5 X4.0)
G	Screw MM200251CI6 (MM2.0X2.5)
J	Screw MM250301CI7 (MM2.5X3.0)
K	Screw MM300351354 (MM3.0X3.5)
L	Screw MM200301CI3 (MM2.0X3.0)
R	Screw MS200401EJ3 (MS2.0X4.0)
S	Screw MM250601L69 (MM2.5X6.0)

Removing the Battery Pack

1. Slide the battery latch.
2. Then remove the battery pack.

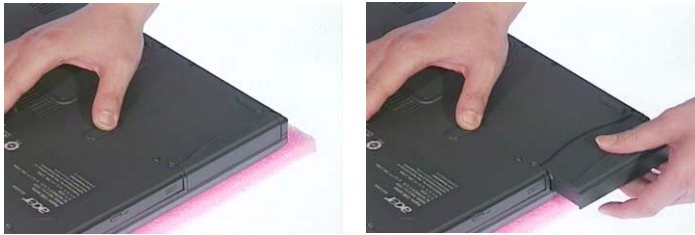

Removing the Memory/HDD Module

1. Remove the screws that secure the ram door.
2. Remove the ram door.
3. Prize the memory lock with fingers then remove the memory.



4. Unscrew the two screws that secure the HDD module.
5. Then remove the HDD module from the notebook computer.



Removing the Keyboard/LCD Module

1. Use a flat head screwdriver to prize the middle cover. Please be careful. Do not scrape the middle cover.
2. Remove the middle cover.



3. Unscrew the three screws that secure the keyboard. Next, turn over the keyboard.
4. Disconnect the keyboard connector then remove the keyboard.

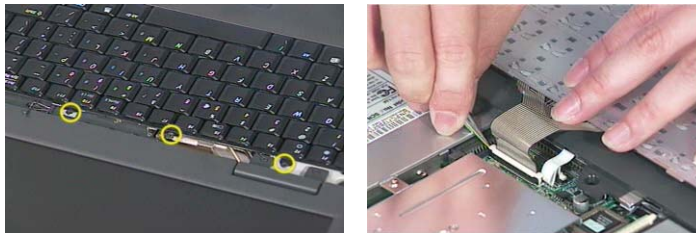

5. Remove the two screws holding the right hinge cover.
6. Unscrew the screw holding the left hinge cover.
7. Remove the two hinge covers.



8. Disconnect the LCD cable.
9. Remove the entire LCD module.



Disassembling the Main Unit

1. Disconnect the fan connector.
2. Remove the three screws holding the fan then remove the fan from the main unit.

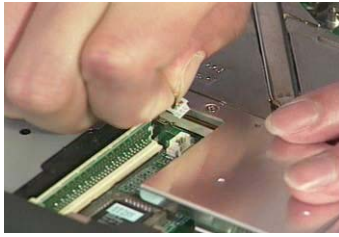

3. Unscrew the five screws that secure the thermal module then remove the thermal module.
4. Use a tool to take out CPU from CPU socket.

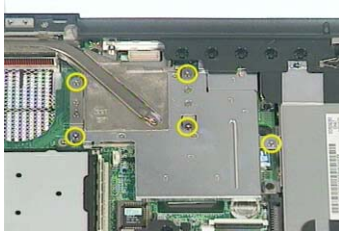

5. Unscrew the screw holding the optical drive.
6. Next remove the optical drive off the main unit.



7. To detach the upper cover from the main unit, first disconnect Tear the mylar from logic upper assembly.
8. Unscrew the screw that secure the upper case to the main board.
9. Remove the three screws on the rear panel.

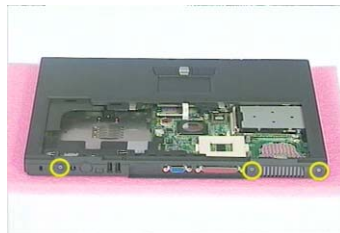

10. Remove the thirteen screws on the base panel.

11. Press the cover latch locating on the right upper corner of the upper case.
12. Then detach the upper case from the lower assembly.



13. Unscrew the four screws that secure the FDD module.
14. Disconnect the FDD FFC then remove the FDD module from the main unit.

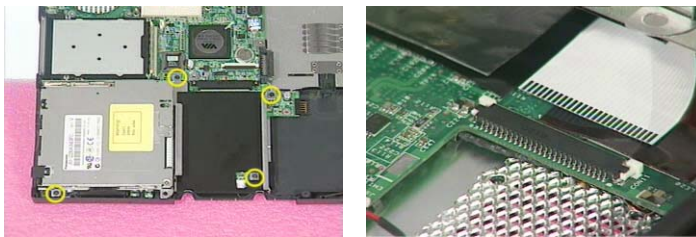

15. Remove the four screw nuts on the rear panel.
16. Unscrew the three screws holding the top cover shielding then remove the top cover shielding.

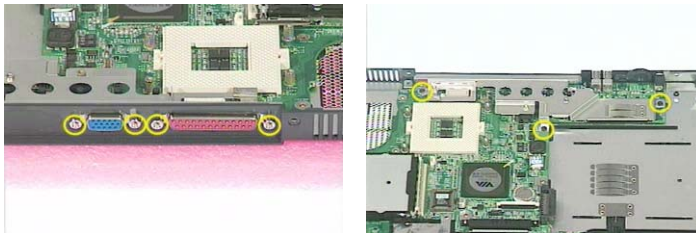

17. Unscrew the four screws that lock the main board.
18. Disconnect the right speaker cable.
19. Disconnect the left speaker cable.



20. Remove the main board off the lower case.
21. Tear off the EMI tape on the main board.

22. Unscrew the four screws that lock the special nuts on the main board.

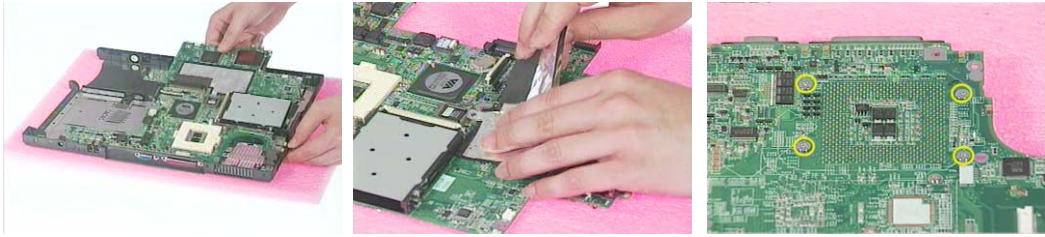

Disassembling the LCD Module-14.1 Inch

1. First, remove the six screw pads then remove the six screws as shown here.
2. Detach the LCD bezel carefully.



3. Disconnect the inverter power cable and LCD CCFT cable, then remove the inverter board.
4. Unscrew the four screws that fix the left and right hinges.



5. Remove the right and the left hinges.
6. Unscrew the four screws that fix the LCD to LCD panel. Two on each side.
7. Then take the LCD off the LCD panel.



8. Remove the four screws that lock the right and the left LCD brackets. Two on each side.
9. Tear off the LCD conductive fabric tape.
10. Tear off the tape that fastens the LCD cable then disconnect the LCD cable.



Disassembling the LCD Module-15.1 Inch

1. First, remove the two screw pads then remove the two screws as shown here.
2. Detach the LCD bezel carefully.
3. Detach the four square screw pads. Two on each side.



4. Unscrew the six screws that fix LCD to the LCD panel; three on each side.
5. Remove the four screws that fix the left and the right hinges; two on each side.
6. Remove the left and the right hinges.



7. Disconnect the inverter board power cable and LCD CCFT cable then remove the inverter board.
8. Take the LCD off the LCD panel.
9. Unscrew the six screws holding the right and the left brackets then remove the LCD brackets.



10. Tear off the conductive fabric tape.
11. Tear off the tape that fastens the LCD cable.
12. Then disconnect the LCD cable.



Disassembling the External Modules

Disassembling the HDD Module

1. Remove the four screws on HDD tray, two on each side.
2. Take the HDD off the HDD tray.

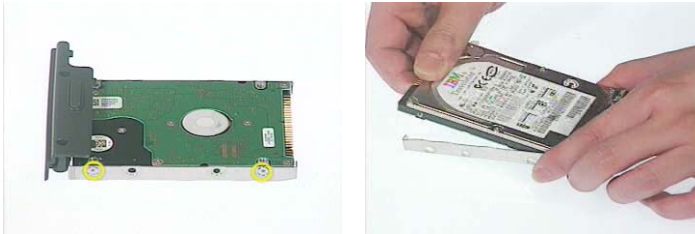

Disassembling the Floppy Disk Drive Module

1. Remove the two screws holding the FDD holder.
2. Remove the screw that fixes the FDD holder then remove the FDD from the FDD holder.
3. Disconnect the FDD FPC.

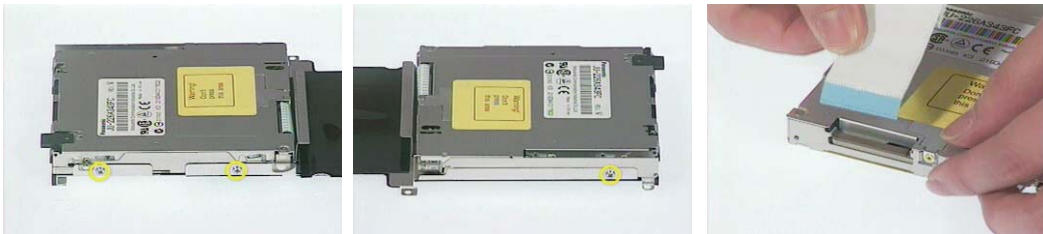

Disassembling the Optical Drive Module

1. Unscrew the two screws holding the optical bracket.
2. Then remove the optical bracket.

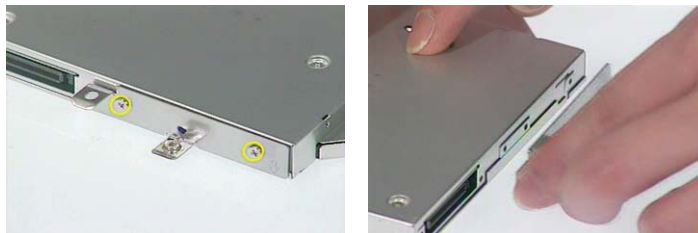

3. Remove the two screws that lock the ODD door.
4. Then remove the ODD door.



Troubleshooting

Use the following procedure as a guide for computer problems.

NOTE: The diagnostic tests are intended to test this model. Non-Acer products, prototype cards, or modified options can give false errors and invalid system responses.

1. Duplicate symptom and obtain the failing symptoms in as much detail as possible.
2. Distinguish symptom. Verify the symptoms by attempting to re-create the failure by running the diagnostic test or by repeating the same operation.
3. Disassemble and assemble the unit without any power sources.
4. If any problem occurs, you can perform visual inspection before you follow this chapter's instructions. You can check the following:
 - power cords are properly connected and secured;
 - there are no obvious shorts or opens;
 - there are no obviously burned or heated components;
 - all components appear normal.
5. Use the following table with the verified symptom to determine which page to go to.

Symptoms (Verified)	Go To
Power failure. (The power indicator does not go on or stay on.)	"Power System Check" on page 57.
POST does not complete. No beep or error codes are indicated.	"Power-On Self-Test (POST) Error Message" on page 59 "Undetermined Problems" on page 67
POST detects an error and displayed messages on screen.	"Error Message List" on page 60
The diagnostic test detected an error and displayed a FRU code.	"System Diagnostic Diskette" on page 40
Other symptoms (i.e. LCD display problems or others).	"Power-On Self-Test (POST) Error Message" on page 59
Symptoms cannot be re-created (intermittent problems).	Use the customer-reported symptoms and go to "Power-On Self-Test (POST) Error Message" on page 59 "Intermittent Problems" on page 66 "Undetermined Problems" on page 67

System Check Procedures

External Diskette Drive Check

Do the following to isolate the problem to a controller, driver, or diskette. A write-enabled, diagnostic diskette is required.

NOTE: Make sure that the diskette does not have more than one label attached to it. Multiple labels can cause damage to the drive or cause the drive to fail.

Do the following to select the test device. See “System Diagnostic Diskette” on page 40 for details.

1. Boot from the diagnostics diskette and start the diagnostics program (see “System Diagnostic Diskette” on page 40).
2. See if FDD Test is passed as the program runs to FDD Test.
3. Follow the instructions in the message window.

If an error occurs with the internal diskette drive, reconnect the diskette connector on the system board.

If the error still remains:

1. Reconnect the external diskette drive/DVD-ROM module.
2. Replace the external diskette drive/CD-ROM module.
3. Replace the main board.

External CD-ROM Drive Check

Do the following to isolate the problem to a controller, drive, or CD-ROM. Make sure that the CD-ROM does not have any label attached to it. The label can cause damage to the drive or can cause the drive to fail.

Do the following to select the test device:

1. Boot from the diagnostics diskette and start the diagnostics program (refer to “System Diagnostic Diskette” on page 40).
2. See if CD-ROM Test is passed when the program runs to CD-ROM Test.
3. Follow the instructions in the message window.

If an error occurs, reconnect the connector on the System board. If the error still remains:

1. Reconnect the external diskette drive/CD-ROM module.
2. Replace the external diskette drive/CD-ROM module.
3. Replace the main board.

Keyboard or Auxiliary Input Device Check

Remove the external keyboard if the internal keyboard is to be tested.

If the internal keyboard does not work or an unexpected character appears, make sure that the flexible cable extending from the keyboard is correctly seated in the connector on the system board.

If the keyboard cable connection is correct, run the Keyboard Test. See “System Diagnostic Diskette” on page 40 for details.

If the tests detect a keyboard problem, do the following one at a time to correct the problem. Do not replace a non-defective FRU:

1. Reconnect the keyboard cables.
2. Replace the keyboard.
3. Replace the main board.

The following auxiliary input devices are supported by this computer:

- Numeric keypad
- External keyboard

If any of these devices do not work, reconnect the cable connector and repeat the failing operation.

Memory Check

Memory errors might stop system operations, show error messages on the screen, or hang the system.

1. Boot from the diagnostics diskette and start the doagmpstotics program (please refer to main board).
2. Go to the diagnostic memory in the test items.
3. Press F2 in the test items.
4. Follow the instructions in the message window.

NOTE: Make sure that the DIMM is fully installed into the connector. A loose connection can cause an error.

Power System Check

To verify the symptom of the problem, power on the computer using each of the following power sources:

1. Remove the battery pack.
2. Connect the power adapter and check that power is supplied.
3. Disconnect the power adapter and install the charged battery pack; then check that power is supplied by the battery pack.

If you suspect a power problem, see the appropriate power supply check in the following list:

- “Check the Battery Pack” on page 58

Check the Battery Pack

To check the battery pack, do the following:

From Software:

1. Check out the Power Management in control Panel
2. In Power Meter, confirm that if the parameters shown in the screen for Current Power Source and Total Battery Power Remaining are correct.
3. Repeat the steps 1 and 2, for both battery and adapter.
4. This helps you identify first the problem is on recharging or discharging.

From Hardware:

1. Power off the computer.
2. Remove the battery pack and measure the voltage between battery terminals 1(+) and 6(ground). See the following figure
3. If the voltage is still less than 7.5 Vdc after recharging, replace the battery.

To check the battery charge operation, use a discharged battery pack or a battery pack that has less than 50% of the total power remaining when installed in the computer.

If the battery status indicator does not light up, remove the battery pack and let it return to room temperature. Re-install the battery pack.

If the charge indicator still does not light up, replace the battery pack. If the charge indicator still does not light up, replace the DC/DC charger board.

Touchpad Check

If the touchpad doesn't work, do the following actions one at a time to correct the problem. Do not replace a non-defective FRU:

1. After rebooting, run Tracking Pad PS2 Mode Driver. For example, run Syn touch driver.
2. Run utility with the PS/2 mouse function and check if the mouse is working.
3. If the the PS/2 mouse does not work, then check if the main board to switch board FPC is connected O.K.
4. If the main board to switch board FPC is connected well, then check if the FCC on touch pad PCB connects properly.
5. If the FFC on touch pad PCB connects properly, then check if LS851 JP1 Pin6=5V are pulese. If yes, then replace switch board. If no, then go to next step.
6. Replace touch pad PCB.
7. If the touch pad still does not work, then replace FPC on Track Pad PCB.

After you use the touchpad, the pointer drifts on the screen for a short time. This self-acting pointer movement can occur when a slight, steady pressure is applied to the touchpad pointer. This symptom is not a hardware problem. No service actions are necessary if the pointer movement stops in a short period of time.

Power-On Self-Test (POST) Error Message

The POST error message index lists the error message and their possible causes. The most likely cause is listed first.

NOTE: Perform the FRU replacement or actions in the sequence shown in FRU/Action column, if the FRU replacement does not solve the problem, put the original part back in the computer. Do not replace a non-defective FRU.

This index can also help you determine the next possible FRU to be replaced when servicing a computer.

If the symptom is not listed, see “Undetermined Problems” on page 67.

The following lists the error messages that the BIOS displays on the screen and the error symptoms classified by function.

NOTE: Most of the error messages occur during POST. Some of them display information about a hardware device, e.g., the amount of memory installed. Others may indicate a problem with a device, such as the way it has been configured.

NOTE: If the system fails after you make changes in the BIOS Setup Utility menus, reset the computer, enter Setup and install Setup defaults or correct the error.

Index of Error Messages

Error Message List

Error Messages	FRU/Action in Sequence
Struck Key	See "Keyboard or Auxiliary Input Device Check" on page 57
System CMOS checksum bad - Default configuration used	RTC battery Run BIOS Setup Utility to reconfigure system, then reboot system.
Real time clock error	RTC battery Run BIOS Setup Utility to reconfigure system time, then reboot system. Main board
Previous boot incomplete - Default configuration used	"Load Default Settings" in BIOS Setup Utility. RTC batter Main board.
Invalid System Configuration Data	"Load Default Settings" in BIOS Setup Utility. Main board.
Operating system not found	Enter Setup and see if fixed disk and drive A are properly identified. Dikette drive Hard disk drive Main board.

Error Message List

No beep Error Messages	FRU/Action in Sequence
Power-on indicator turns off and LCD is blank.	Power source (battery pack and power adapter.) See "Power System Check" on page 57 Ensure every connector is connected tightly and correctly. Reconnect the DIMM. Main board.
Power-on indicator turns on and LCD is blank.	Power source (battery pack and power adapter.) See "Power System Check" on page 57 Reconnect the LCD connector Hard disk drive LCD cable LCD inverter LCD Main board
Power-on indicator turns on and LCD is blank. But you can see POST on an external CRT.	Reconnect the LCD connectors. LCD cable LCD inverter LCD Main board
Power-on indicator turns on and a blinking cursor shown on LCD during POST.	Ensure every connector is connected tightly and correctly. Main board

Index of Symptom-to-FRU Error Message

LCD-Related Symptoms

Symptom / Error	Action in Sequence
LCD backlight doesn't work	First, plug a monitor to CRT port. Next, enter BIOS utility to running "Load Default Settings" then reboot the system. Reconnect the LCD connectors. Keyboard (if the brightness function key doesn't work). LCD cable LCD inverter LCD Main board
LCD is too dark LCD brightness cannot be adjusted	Enter BIOS Utility to execute "Load Setup Default Settings", then reboot system. Reconnect the LCD connectors. Keyboard (if the brightness function key doesn't work). LCD cable LCD inverter LCD Main board
Unreadable LCD screen Missing pels in characters Abnormal screen Wrong color displayed LCD has extra horizontal or vertical lines displayed.	Reconnect the LCD cable LCD cable LCD Main board

Indicator-Related Symptoms

Symptom / Error	Action in Sequence
Indicator incorrectly remains off or on, but system runs correctly	Main board
HDD/CD-ROM active indicators cannot work	HDD/CD-ROM drive Device driver Main board

Power-Related Symptoms

Symptom / Error	Action in Sequence
Power shuts down during operation	Power source (battery pack and power adapter). See "Power System Check" on page 57. Battery pack AC adapter See if the thermal module is overheat (Heat sink or fan). Main board
The system cannot power-on.	Power source (battery pack and power adapter). See "Power System Check" on page 57. Battery pack Power adapter CPU Main board
The system cannot power-off.	In Windows XP operating system, hold and press the power switch for more than 4 seconds. If the system can power off, then the main board is OK. Verify OS in the HDD. Main board

Power-Related Symptoms

Symptom / Error	Action in Sequence
Battery can't be charged or discharged	See "Check the Battery Pack" on page 58. Battery pack Main board
System hang during POST	ODD/HDD/FDD/RAM module Main board

PCMCIA-Related Symptoms

Symptom / Error	Action in Sequence
System cannot detect the PC Card (PCMCIA)	PCMCIA slot assembly Main board
PCMCIA slot pin is damaged.	PCMCIA slot assembly
PC Card cannot be inserted or ejected	Check if the PCMCIA slot is blocked Main board

Memory-Related Symptoms

Symptom / Error	Action in Sequence
Memory count (size) appears different from actual size.	Enter BIOS Setup Utility to execute "Load Default Settings" then reboot system. RAM module Main board Check BIOS revision
System can power on, but you hear two long beeps: "B--, B--" and the LCD is blank.	Reinsert DIMM DIMM Main board

Speaker-Related Symptoms

Symptom / Error	Action in Sequence
In Windows, multimedia programs, no sound comes from the computer.	OS volume control Audio driver Speaker Main board
Internal speakers make noise or emit no sound.	Speaker Main board
Microphone cannot work	Audio driver Volume control in Windows XP Main board

Power Management-Related Symptoms

Symptom / Error	Action in Sequence
The system will not enter hibernation mode	Power option in Windows XP Hard disk drive Main board
The system doesn't enter standby mode after closing the lid of the portable computer.	Driver of Power Option Properties Lid close switch in upper case Main board

Power Management-Related Symptoms

Symptom / Error	Action in Sequence
The system doesn't resume from hibernation/standby mode.	Connect AC adapter then check if the system resumes from Standby/Hibernation mode. Check if the battery is low. Hard disk drive Main board
The system doesn't resume from standby mode after opening the lid of the portable computer.	LCD cover switch Main board
Battery fuel gauge in Windows doesn't go higher than 90%.	Refresh battery (continue use battery until power off, then charge battery). Battery pack Main board
System hangs intermittently.	Reconnect hard disk/CD-ROM drives. Main board

Peripheral-Related Symptoms

Symptom / Error	Action in Sequence
System configuration does not match the installed devices.	Enter BIOS Setup Utility to execute "Load Setup defaults", then reboot system. Reconnect hard disk/CD-ROM drives/FDD or other peripherals. Main board
External display does not work correctly.	Press Fn+F5, LCD/CRT/Both display switching Keyboard Main board
USB does not work correctly	See "System Diagnostic Diskette" on page 40 Main board
Print problems.	Enter BIOS Setup Utility to execute "Load Default Settings" then reboot the system. Run printer self-test. Printer driver Printer cable Printer Main board
Parallel port device problems	Enter BIOS Setup Utility to execute "Load Default Settings" then reboot the system. Device driver Device cable Device Main board

Keyboard/Touchpad-Related Symptoms

Symptom / Error	Action in Sequence
Keyboard (one or more keys) does not work.	Reconnect the keyboard cable. Keyboard Main board
Touchpad does not work.	Reconnect touchpad cable. Touchpad board Main board

Modem/LAN-Related Symptoms

Symptom / Error	Action in Sequence
Internal modem does not work correctly.	See "System Diagnostic Diskette" on page 40. Phone cable Driver Reconnect the Internal modem cable to the main board tightly. Main board
Internal LAN does not work correctly	Lan cable Driver Main board

NOTE: If you cannot find a symptom or an error in this list and the problem remains, see "Undetermined Problems" on page 67.

Intermittent Problems

Intermittent system hang problems can be caused by a variety of reasons that have nothing to do with a hardware defect, such as: cosmic radiation, electrostatic discharge, or software errors. FRU replacement should be considered only when a recurring problem exists.

When analyzing an intermittent problem, do the following:

1. Run the diagnostic test for the system board in loop mode at least 10 times.
2. If no error is detected, do not replace any FRU.
3. If any error is detected, replace the FRU. Rerun the test to verify that there are no more errors.

Undetermined Problems

The diagnostic problems does not identify which adapter or device failed, which installed devices are incorrect, whether a short circuit is suspected, or whether the system is inoperative.

Follow these procedures to isolate the failing FRU (do not isolate non-defective FRU).

NOTE: Verify that all attached devices are supported by the computer.

NOTE: Verify that the power supply being used at the time of the failure is operating correctly. (See “Power System Check” on page 57):

1. Power-off the computer.
2. Visually check them for damage. If any problems are found, replace the FRU.
3. Remove or disconnect all of the following devices:
 - Non-Acer devices
 - Printer, mouse, and other external devices
 - Battery pack
 - Hard disk drive
 - DIMM
 - PC Cards
4. Power-on the computer.
5. Determine if the problem has changed.
6. If the problem does not recur, reconnect the removed devices one at a time until you find the failing FRU.
7. If the problem remains, replace the following FRU one at a time. Do not replace a non-defective FRU:
 - System board
 - LCD assembly

Jumper and Connector Locations

Top View

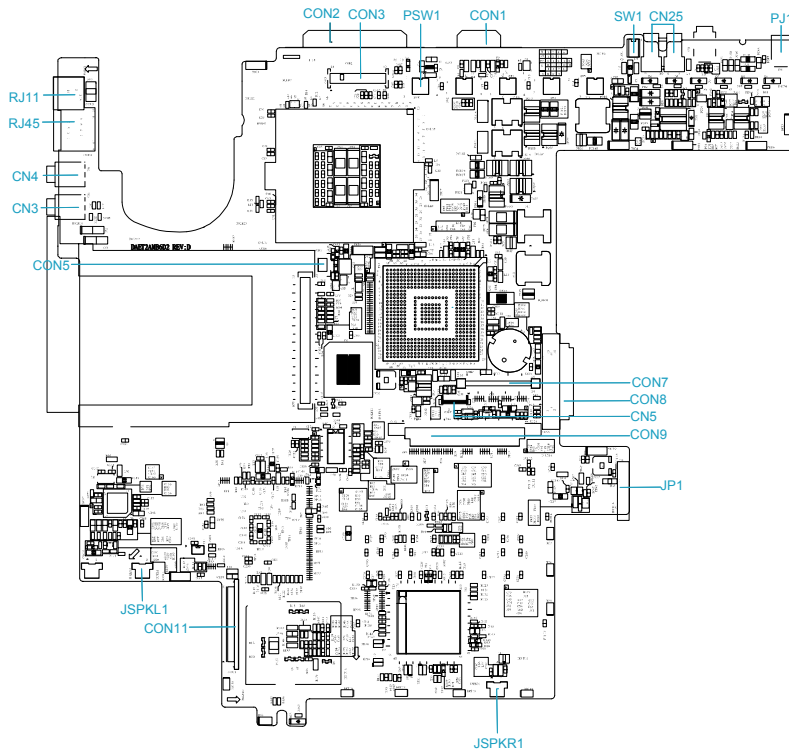

CON2	Parallel connector	CON9	HDD connector
CON3	LCD cable connector	JP1	Battery connector
PSW1	Power on switch	JSPKR1	Right speaker connector
CON1	VGA connector	CON11	FDD FPC connector
SW1	Lid switch	JSPKL1	Left speaker connector
CN25	USB connectorX2	CON5	FAN connector
PJ1	Adapter connector	CN3	Headphone jack
CON7	Keyboard FFC connector	CN4	Microphone-in jack
CON8	CD/DVD-ROM module connector	RJ45	LAN connector
CN5	Touchpad FFC connector	RJ11	Modem connector

Bottom View

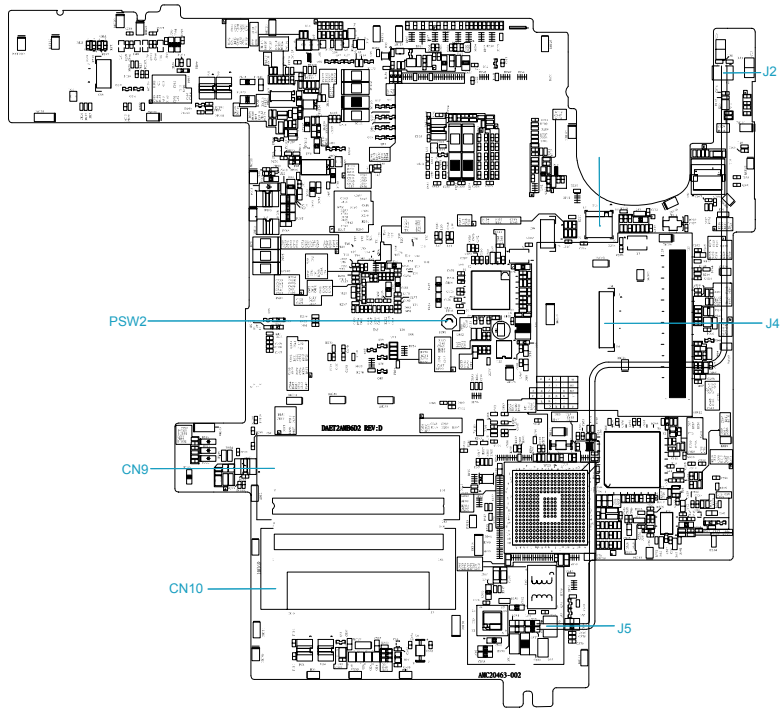

- J2 Modem cable connector
- J4 Debug port connector
- J5 Modem cable connector
- CN10 DIMM connector 2
- CN9 DIMM connector 1
- PSW2 System-off switch

FRU (Field Replaceable Unit) List

This chapter gives you the FRU (Field Replaceable Unit) listing in global configurations of Aspire 1300. Refer to this chapter whenever ordering for parts to repair or for RMA (Return Merchandise Authorization). Please also note that there are some common parts for Aspire 1300, yet the LCD modules are different in two model.

Please note that WHEN ORDERING FRU PARTS, you should check the most up-to-date information available on your regional web or channel. For whatever reasons a part number change is made, it will not be noted on the printed Service Guide. For ACER AUTHORIZED SERVICE PROVIDERS, your Acer office may have a DIFFERENT part number code from those given in the FRU list of this printed Service Guide. You MUST use the local FRU list provided by your regional Acer office to order FRU parts for repair and service of customer machines.

NOTE: To scrap or to return the defective parts, you should follow the local government ordinance or regulations on how to dispose it properly, or follow the rules set by your regional Acer office on how to return it.

Exploded Diagram

THE SYSTEM

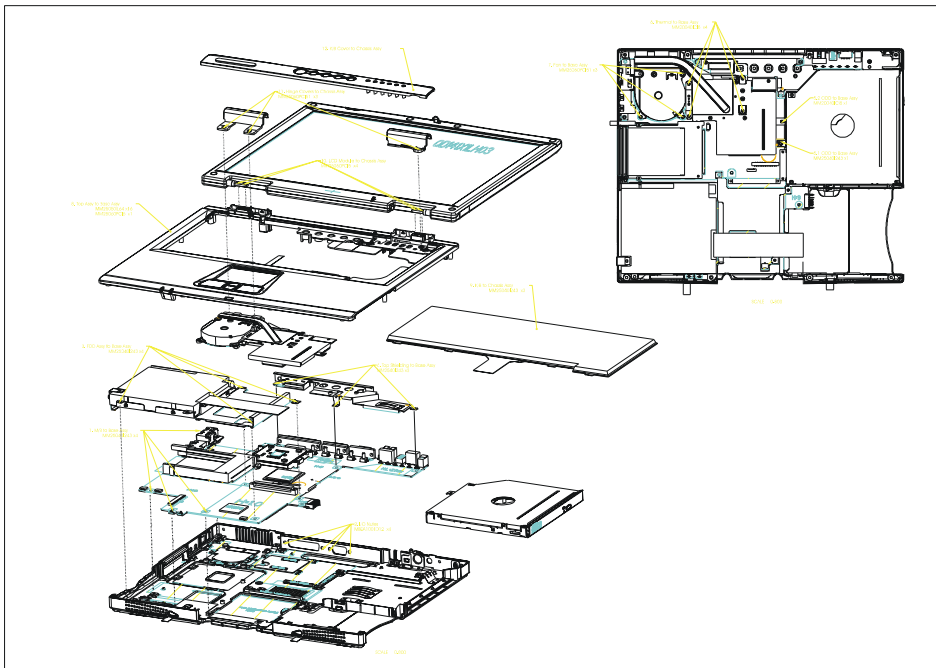

LCD 14.1"

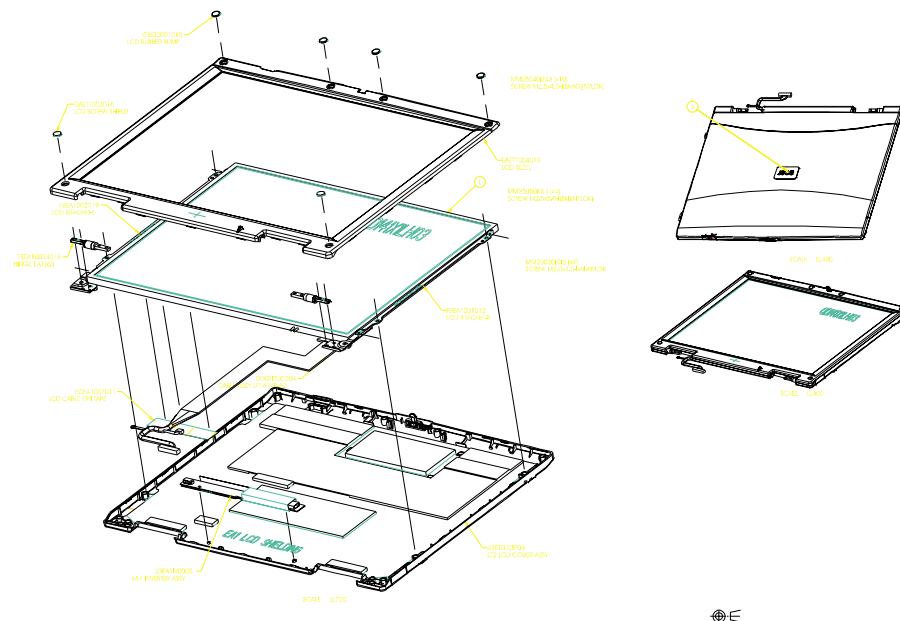

LCD 15.0"

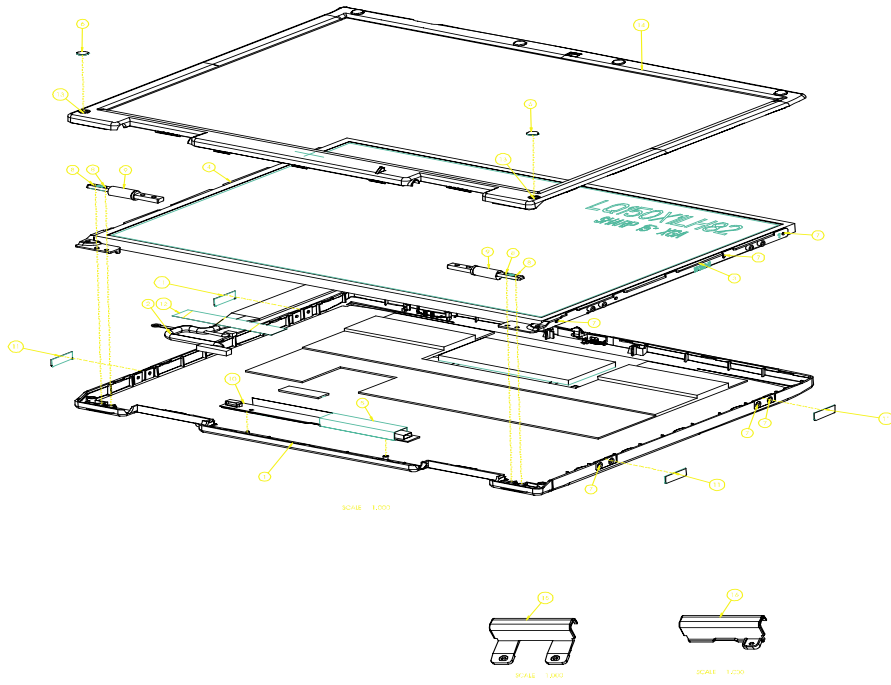



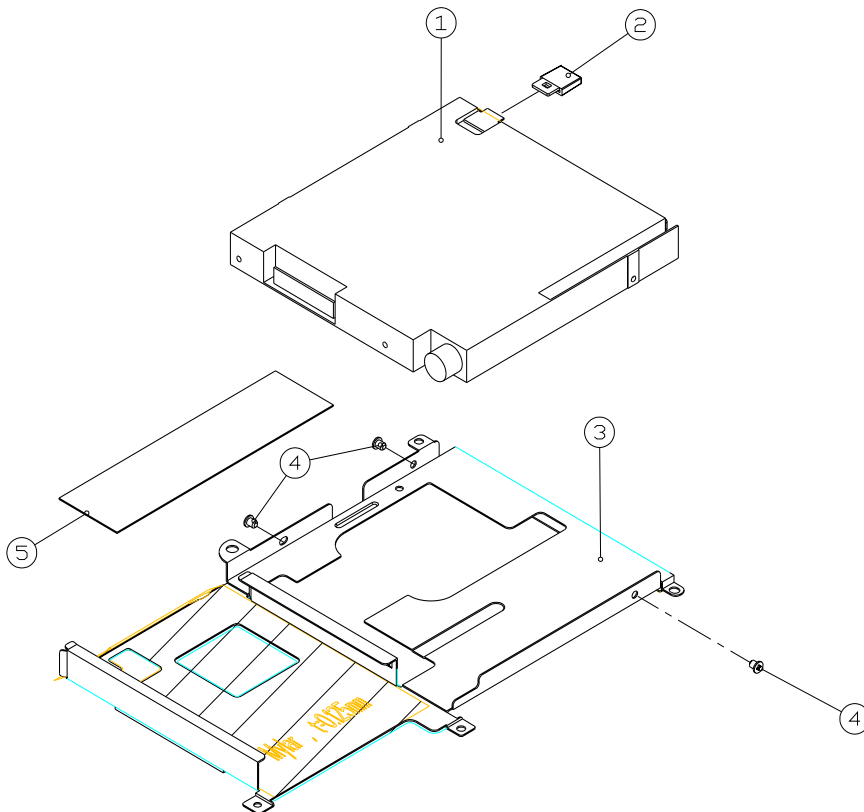







FDD ASSY







Picture	No.	Partname And Description	Part Number
CPU/Processor			
	THE SYSTEM	AMD ATHLON XP 1.2G(1400+) 35W TOROUGHNBRED	KC.A1402.001
		AMD ATHLON XP 1.4G(1600+) 35W TOROUGHNBRED	KC.A1802.001
		AMD ATHLON XP 1.5G(1800+) 35W TOROUGHNBRED	
Memory			
	NS	MEMORY SDIMM 128M MICRON PC-133	KS.12804.001
		MEMORY SDIMM 128M INFINION PC-133	KS.12802.002
		MEMORY SDIMM 128M NANYA PC-133	KS.12803.001
		MEMORY SDIMM 128M ELPIDA PC-133	
		MEMORY SDIMM 128M MITSUBISHI PC-133	KS.12808.001
		MEMORY SDIMM 256M MICRON PC-133	KS.25604.001
		MEMORY SDIMM 256M INFINION PC-133	KS.25602.002
		MEMORY SDIMM 256M NANYA PC-133	KS.25603.001
		MEMORY SDIMM 256M ELPIDA PC-133	
		MEMORY SDIMM 256M MITSUBISHI PC-133	KS.25608.001
LCD			
	THE SYSTEM	LCD MODULE 14.1" QDI	6M.A03V7.031
		LCD MODULE 14.1" SAMSUNG	6M.A03V7.032
		LCD MODULE 14.1" AU	6M.A03V7.033
		LCD MODULE 15.0" LG	6M.A03V7.034
		LCD MODULE 15.0" SHARP	6M.A03V7.035
		LCD MODULE 15.0" AU	6M.A03V7.036
	1-LCD 14.1"	LCD 14.1" TFT XGA QDI QD141X1LH03	LK.A0309.001
	4--LCD 15.0"	LCD 14.1" TFT XGA SAMSUNG LTN141X8-L04	LK.A0309.002
		LCD 14.1" TFT XGA B141XN04 AU	LK.A0309.003
		LCD 15.0" XGA TFT LG LP150X2-A2M1	LK.A0309.004
		LCD 15.0" XGA TFT SHARP LQ150X1LH82	LK.A0309.005
		LCD 15.0" XGA TFT AU B150XN01	LK.A0309.006
	10-LCD	LCD INVERTER W/MAYLARE	19.A03V7.001
	15.0"		
	FBEA10010	ASSY 14.1" BRACKET R	33.A03V7.004
	12-LCD 14.1"		
	FBEA10020	ASSY 14.1" BRACKET L	33.A03V7.005
	19-LCD 14.1"		

Picture	No.	Partname And Description	Part Number
	9-LCD 15.0"	ASSY 14.1" HINGE R/L	6K.A03V7.004
	3-LCD 15.0"	ASSY 15.0" BRACKET R	33.A03V7.006
	4--LCD 15.0"	ASSY 15.0" BRACKET L	33.A03V7.007
	1-LCD 15.0"	LCD PANEL WITH LOGO 14.1" LCD PANEL WITH LOGO 15.0"	60.A03V7.003 60.A03V7.005
	14-LCD 15.0"	LCD BEZEL 14.1" LCD BEZEL 15.0" (WITH RUBBER FEET)	60.A03V7.004 60.A03V7.006
	DDOET2LC 204-LCD 14.1"	LCD WIRE 14.1" QDI LCD WIRE 14.1" SAMSUNG LCD WIRE 14.1" AU LCD WIRE 15.0" LG LCD WIRE 15.0" SHARP LCD WIRE 15.0" AU	50.A03V7.002 50.A03V7.003 50.A03V7.004 50.A03V7.005 50.A03V7.006 50.A03V7.007
FDD/Floppy Disk Drive			
	NS	FDD MODULE, PANASONIC	6M.A03V7.011
	1-FDD ASSY	FDD 1.44MB PANASONIC JU-226A343FC(V)	KF.A0302.001
	5-FDD ASSY	FDD FFC	50.A03V7.001

Picture	No.	Partname And Description	Part Number
	3-FDD ASSY	FDD HOLDER-PANASONIC	33.A03V7.002
HDD/ Hard Disk Drive			
	NS	HDD MODULE 20G TOSHIBA HDD MODULE 20G IBM HDD MODULE 30G IBM	6M.A03V7.021 6M.A03V7.022 6M.A03V7.023
	NS	HDD TOSHIBA 20G(MK2018GAP), TITAN HDD IBM 20G(IC25N020ATCS04-0), 07N8325, CASCADE HDD IBM 30G(IC25N030ATCS04-0), 07N8326, CASCADE	KH.25204.001 KH.25202.001 KH.25302.001
	NS	HDD CARRIER	33.A03V7.003
Optical Drive/Combo Drive			
	THE SYSTEM	CD-ROM MODULE 24X QSI CD-ROM MODULE 24X PANASONIC DVD-ROM MODULE 8X QSI DVD-ROM MODULE 8X PANASONIC DVD-RW COMBO MODULE 16X QSI DVD-RW COMBO MODULE 16X PANASONIC DVD-RW COMBO MODULE 16X TOSHIBA	6M.A03V7.001 6M.A03V7.002 6M.A03V7.003 6M.A03V7.004 6M.A03V7.005 6M.A03V7.006 6M.A03V7.007
		CD-ROM 24X QSI SCR-242 CD-ROM 24X PANASONIC CR-177-DPK1 DVD-ROM 8X QSI SDR-083 DVD-ROM 8X PANASONIC SR8177 DVD-RW COMBO 16X QSI SBW-161 DVD-RW COMBO 16X PANASONIC UJDA730 DVD-RW COMBO 16X TOSHIBA SD-R2212	KD.24X02.001 KD.24X05.001 KV.08X03.001 KV.08X07.001 KO.16X07.001 KO.16X06.001 KO.08X04.002
		CD-ROM DOOR QSI CD-ROM DOOR PANASONIC DVD-ROM DOOR QSI DVD-ROM DOOR PANASONIC DVD-RW DOOR QSI DVD-RW DOOR PANASONIC DVD-RW DOOR TOSHIBA	42.A03V7.011 42.A03V7.012 42.A03V7.021 42.A03V7.022 42.A03V7.023 42.A03V7.031 42.A03V7.032

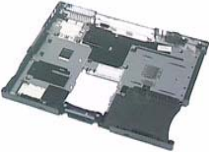
Picture	No.	Partname And Description	Part Number
		ODD BRACKET	33.A03v7.001
Fan			
	THE SYSTEM	FAN	31.A03V7.001
Cables			
	NS	POWER CORD-US POWER CORD-CONTINENTAL POWER CORD-PRC POWER CORD-UK POWER CORD-ITALIAN POWER CORD-DANISH POWER CORD-SWISS	27.A03V7.001 27.A03V7.002 27.A03V7.003 27.A03V7.004 27.A03V7.005 27.A03V7.006 27.A03V7.007
Boards			
	THE SYSTEM	MAIN BOARD W/LAN	MB.A0306.001
Adapter			
	NS	ADAPTER DELTA 75W ADP-75FB B (W PFC), 3P ADAPTER LITE-ON 75W PA-1750-02Q(W PFC), 3P	AP.A0305.001 AP.A0305.002
Battery			
	NS	BATTERY SANYO LI-ION 4000mAH BATTERY PANASONIC-LI-ION 4000mAH BATTERY SANYO NI-MH 4000mAH	BT.A0302.001 BT.A0302.002 BT.A0302.003
Keyboard			

Picture	No.	Partname And Description	Part Number
	9-THE SYSTEM	ASPIRE 1300 KEYBOARD JIMMOLD US	KB.A0305.001
		ASPIRE 1300 KEYBOARD JIMMOLD UK	KB.A0305.002
		ASPIRE 1300 KEYBOARD JIMMOLD GERMAN	KB.A0305.003
		ASPIRE 1300 KEYBOARD JIMMOLD ITALIAN	KB.A0305.004
		ASPIRE 1300 KEYBOARD JIMMOLD CHINESE	KB.A0305.005
		ASPIRE 1300 KEYBOARD JIMMOLD FRENCH	KB.A0305.006
		ASPIRE 1300 KEYBOARD JIMMOLD SWISS/G	KB.A0305.007
		ASPIRE 1300 KEYBOARD JIMMOLD SPANISH	KB.A0305.008
		ASPIRE 1300 KEYBOARD JIMMOLD PROTUGUESE	KB.A0305.009
		ASPIRE 1300 KEYBOARD JIMMOLD ARABIC	KB.A0305.010
		ASPIRE 1300 KEYBOARD JIMMOLD THAI	KB.A0305.011
		ASPIRE 1300 KEYBOARD JIMMOLD BELGIUM	KB.A0305.012
		ASPIRE 1300 KEYBOARD JIMMOLD SWEDEN	KB.A0305.013
		ASPIRE 1300 KEYBOARD JIMMOLD CZECH	KB.A0305.014
		ASPIRE 1300 KEYBOARD JIMMOLD HUNGAIAN	KB.A0305.015
		ASPIRE 1300 KEYBOARD JIMMOLD NORWAY	KB.A0305.016
		ASPIRE 1300 KEYBOARD JIMMOLD DANISH	KB.A0305.017
		ASPIRE 1300 KEYBOARD JIMMOLD TURKISH	KB.A0305.018
		ASPIRE 1300 KEYBOARD JIMMOLD JAPANESE	KB.A0305.019
		ASPIRE 1300 KEYBOARD JIMMOLD KOREAN	KB.A0305.020
ASPIRE 1300 KEYBOARD JIMMOLD DUTCH	KB.A0305.021		
ASPIRE 1300 KEYBOARD JIMMOLD RUSSIAN	KB.A0305.022		
ASPIRE 1300 KEYBOARD JIMMOLD SLOVAK	KB.A0305.023		
ASPIRE 1300 KEYBOARD JIMMOLD SLOVENIAL	KB.A0305.024		
ASPIRE 1300 KEYBOARD JIMMOLD POLISH	KB.A0305.025		
ASPIRE 1300 KEYBOARD JIMMOLD BRAZIL	KB.A0305.027		
Case/Cover/Bracket Assembly			
	12-THE SYSTEM	MIDDLE COVER W/ NAME PLATE	42.A03V7.001
	NS	RAM DOOR W/ CAPTURED SCREW	42.A03V7.002
	THE SYSTEM	LOWER CASE ASSY W/O SPEAKER	60.A03V7.001
	8-THE SYSTEM	UPPER CASE ASSY W/ TOUCHPAD	60.A03V5.002

Picture	No.	Partname And Description	Part Number
	15/16-LCD 15.0"	HINGE COVER KIT-14.1"	6K.A03V7.001
	15/16-LCD 15.0"	HINGE COVER KIT-15.0"	6K.A03V7.002
	THE SYSTEM	TOP COVER SHIELDING	34.A03V7.001
Others			
	NS	SPEAKER ASSY (L & R)	6K.A03V7.006
	THE SYSTEM	THERMAL MODULE W/ HEATSINK	6K.A03V7.007
	NS	THERMAL PAD	47.A03V7.001
		RUBBER FEET (BASE)	47.A03V7.002
	12-LCD 15.0"	LCD DOWNSIDE TAPE	47.A03V7.003
	5-LCD 15.0"	IINVERTER MAYLARE	47.A03V7.004
	GBET20010 10/ GAET10030 16-LCD 14.1"	14.1" LCD SCREW COVER KIT	47.A03V7.005
	11-LCD 15.0"	15.0" LCD SCREW COVER KIT	47.A03V7.006
Screws			
		SCREW, MBEA1001012	V86.0550.001
		SCREW, MS30035I354	86.A03V7.001
		SCREW, MM25050IL64	86.A03V7.002

Picture	No.	Partname And Description	Part Number
		SCREW, MM25060PCI5	86.A03V7.003
		SCREW, MM20040ICI8	86.A03V7.004
		SCREW, MM25040I243	86.A03V7.005
		SCREW MM20025ICI6	86.A03V7.006
		SCREW MS17025B202	86.A03V7.007
		SCREW MM17035IEC8	86.A03V7.008
		SCREW MM25030ICI7	86.A03V7.009
		SCREW MM30035I354	86.A03V7.010
		SCREW MM20030ICI3	86.A03V7.011
		SCREW MM20060ICI7	86.A03V7.012
		SCREW MS20025IG57	86.A03V7.013
		SCREW MS25040IH41	86.A03V7.014
		SCREW MM20040IBJ7	86.A03V7.015
		SCREW MBET2001018	86.A03V7.016
		SCREW MS20040IEJ3	86.A03V7.017
		SCREW MM25060IL69	86.A03V7.018

Model Definition and Configuration

Aspire 1300 series

Model Number	CPU	LCD	ODD	Memory	HDD (GB)	Bat.
1300X	AMD Athlon XP1400+	14.1XGA	24X CD-ROM	128	20	Ni-MH
1300XC	AMD Athlon XP1400+	14.1XGA	8/16/12/24 Combo	256	20	Li-ion
1300XV	AMD Athlon XP1400+	14.1XGA	8X DVD	256	20	Li-ion
1300DXV	AMD Duron 1.2GHz	14.1XGA	8X DVD	128	20	Ni-MH
1304LC	AMD Athlon XP1800+	15.0XGA	8/16/12/24 Combo	256	20	Li-ion

Main Features

- ❑ AMD Athlon XP1400+, XP1600+, or higher processor
- ❑ VIA ProSavage KN133 (Twister K)+VT8362 & VT8231 chipset
- ❑ 2 memory slots supporting 133MHz SDRAM (PC-133), upgradeable to 1GB
- ❑ 10GB, 20GB or 30GB Enhanced-IDE hard disk
- ❑ Microsoft Windows XP operating system

Test Compatible Components

This computer's compatibility is tested and verified by Acer's internal testing department. All of its system functions are tested under Windows XP Home environment.

Refer to the following lists for components, adapter cards, and peripherals which have passed these tests. Regarding configuration, combination and test procedures, please refer to the Aspire 1300 Compatibility Test Report released by the Acer Mobile System Testing Department.

Microsoft Windows XP (Home) Environment Test

Item	Specifications
Display	Philips 4CM8294/17T (DDC, Energy Star) SNI MCM1703 (DDC, Energy Star) NEC C&C-15R1 ViewSonic GS771
PC Card	
Modem Card	Xircom CreditCard Modem 56 (CM-56) Xircom CreditCard Modem 56 (CM-56G) 3Com 56K Modem (XJ1560)
LAN Card	D-Link Fast Ethernet DFE-650 D-Link CardBus DFE-660 3COM 10/100 16Bit LAN Card (3CCFE574BT) 3COM 10/100CardBus LAN Card (3CCFE575BT) Xircom CreditCard Ethernet 10/100 (CE3B-100BTX) Xircom CardBus Ethernet II 10/100 (CBE2-100BTX)
SCSI	Adaptec Slim SCSI APA-1450A Card Adaptec Slim SCSI 1480 CardBus UltraSCSI Card
LAN+Modem Card	3COM 10/100 LAN+56K Modem Card (3CCFE556B) Xircom CreditCard Ethernet+Modem 56K (CEM56-100)
ATA Card	KingMax 40MB Compact Flash 96MB
Wireless LAN Card	Gemtek Wireless LAN Card
BlueTooth Card	3Com BlueTooth Card
Modem Adapters	
Modem	Xircom Winglobal Carbus Modem 56K
I/O Peripheral	
I/O - Parallel (Printer)	HP Laser Jet 5M HP Desk Jet 890C IOMega ZIP (LPT Port)
I/O - USB (Keyboard)	Microsoft Internet Keyboard Pro Gateway Keyboard SK-9910U Gateway Keyboard SK-9926
I/O - USB (Mouse)	Microsoft Optical USB Mouse Lotitech Wheel Mouse Acer USB Mouse M012B0
I/O-USB (Camera)	Microtek EyeStar U2S PC Camera USC-1
I/O-USB (HDD)	Argosy HDD
I/O-USB (CD-ROM)	IOMega ZIP CD650
I/O-USB (Printer)	HD DeskJet 840C
I/O-USB (FDD)	MIC USB FDD YD-8U10
I/O-USB (LAN)	3Com USB LAN
I/O-USB (Zip)	Iomega USB ZIP
I/O-USB (Scanner)	HP ScanJet 5200
I/O-USB (Speaker)	Philips USB speaker
I/O - USB (Speaker)	Panasonic USB Speaker EAB-MPC57 Phillips DSS350 Speaker

Item	Specifications
Audio Jacks	JS-100 Jazz 3D Speaker SONY Earphone MDR-CD60 Microsoft Microphone
Microphone	Condenser MIC. Dynamic MIC.

Online Support Information

This section describes online technical support services available to help you repair your Acer Systems.

If you are a distributor, dealer, ASP or TPM, please refer your technical queries to your local Acer branch office. Acer Branch Offices and Regional Business Units may access our website. However some information sources will require a user i.d. and password. These can be obtained directly from Acer CSD Taiwan.

Acer's Website offers you convenient and valuable support resources whenever you need them.

In the Technical Information section you can download information on all of Acer's Notebook, Desktop and Server models including:

- Service guides for all models
- User's manuals
- Training materials
- Main manuals
- Bios updates
- Software utilities
- Schematics
- Spare parts lists
- Chips
- TABs (Technical Announcement Bulletin)

The service repair section provides you with downloadable information on:

- Troubleshooting guides
- Tooling box information
- Repair instructions for specific models
- Basic repair guidelines
- Debug cards for Acer's latest models

For these purposes, we have included an Acrobat File to facilitate the problem-free downloading of our technical material.

Also contained on this website are:

- Detailed information on Acer's International Traveler's Warranty (ITW)
- Returned material authorization procedures
- An overview of all the support services we offer, accompanied by a list of telephone, fax and email contacts for all your technical queries.

We are always looking for ways to optimize and improve our services, so if you have any suggestions or comments, please do not hesitate to communicate these to us.

A

AC Adapter 33
 ACPI 1.0a 28
 AFLASH Utility 40
 Audio 31, 32

B

Battery 32
 Battery Pack 45
 BIOS 28
 package 28
 password control 28
 ROM size 28
 ROM type 28
 vendor 28
 Version 28
 BIOS Setup Utility 37
 BIOS Supports protocol 28
 BIOS Utility 37
 Navigating 37
 System Information 38
 System Security 39
 Board Layout 12
 Bottom View 14
 Top View 12

C

Cache
 controller 28
 size 28
 CardBus 32
 computer
 on indicator 21
 Core logic 32
 CPU
 core voltage 28
 package 28
 type 28

D

DIMM 28
 Combinations 29
 external 46
 package 28
 removing 46
 Speed 28
 voltage 28
 Disassembly

Battery Pack 44
 CD-ROM/DVD-ROM Module 48
 Floppy Disk Drive 51, 52
 Machine 41
 Procedure Flowchart 43

Display 11
 DVD-ROM Interface 30

E

Error Symptom-to-Spare Part Index 59
 External CD-ROM Drive Check 56
 External Diskette Drive Check 56

F

Features 9
 features 83
 Flash Utility 40
 Floppy Disk
 removing the 51, 52
 Floppy Disk Drive Interface 29
 FRU (Field Replaceable Unit) List 71

H

Hard disk 30, 32
 Hardware Specifications and Configurations 27
 HDD 30, 32
 Hot Keys 21, 22

I

Indicators 21
 Intermittent Problems 66

J

Jumper and Connector Locations 69
 Top View 69

K

Keyboard 32
 Keyboard or Auxiliary Input Device Check 57

L

L2 cache 28
 LAN/Modem Combo 29

M

Machine Disassembly 41

Memory Check 57
Model Definition 82
Modem 29
Modem Combo Card
 external 47

O

Online Support Information 89
Overview 82

P

Panel 15
 Bottom 20
 left 15
 Rear 18
 right 18
Parallel Port 31
PC Card 21, 32
PCMCIA 32
Power System Check 57
 Battery Pack 58
Processor 28

R

RMA 71
RTC 32

S

Second Level Cache 28
Super I/O 32
System
 Block Diagram 11
 Layout 12
System Check Procedures 56
System Diagnostic Diskette 40
System Memory 28
System Specifications 82
 Features 83
System Utilities 37
System Utility Diskette 40

T

Temperature 35
Test Compatible Components 85
Touchpad Check 58
Troubleshooting 55

U

Undetermined Problems 67

USB 32
Utility
 BIOS 37

V

Video 31
 Resolutions 31
Video controller 32

W

Windows XP Home Environment Test 86