

Extensa 500 Notebook

Service Guide

Service Guide files and updates are available on Acer Intranet and CSD database on Lotus Notes.
For more detailed information, please refer to Service CD kit.

Copyright

Copyright * 1996 by Acer Incorporated. All rights reserved. No part of this publication may be reproduced, transmitted, transcribed, stored in a retrieval system, or translated into any language or computer language, in any form or by any means, electronic, mechanical, magnetic, optical, chemical, manual or otherwise, without the prior written permission of Acer Incorporated.

Disclaimer

Acer Incorporated makes no representations or warranties, either expressed or implied, with respect to the contents hereof and specifically disclaims any warranties of merchantability or fitness for any particular purpose. Any Acer Incorporated software described in this manual is sold or licensed "as is". Should the programs prove defective following their purchase, the buyer (and not Acer Incorporated, its distributor, or its dealer) assumes the entire cost of all necessary servicing, repair, and any incidental or consequential damages resulting from any defect in the software. Further, Acer Incorporated reserves the right to revise this publication and to make changes from time to time in the contents hereof without obligation of Acer Incorporated to notify any person of such revision or changes.

Acer is a registered trademark of Acer Incorporated.

Intel is a registered trademark of Intel Corporation.

Pentium is a trademark of Intel Corporation.

Other brand and product names are trademarks and/or registered trademarks of their respective holders.

PART No: 49.42B02.001.....PRINT IN TAIWAN
DOC No: SG281-9807A

Table of Contents

Chapter 1 System Introduction

Basic Operation	11
Indicators	11
Keyboard	12
Special Keys	12
Hardware Configuration and Specification	17
Memory Address Map	17
Interrupt Channel Assignment	17
DMA Channel Assignment	18
I/O Address Map	18
Processor	19
BIOS	19
System Memory	20
DIMM Combinations	20
Video Memory	21
Cache Memory	21
Video	21
Video Resolutions Modes	21
Parallel Port	22
Serial Port	22
Audio	23
PCMCIA	23
Modem	23
Keyboard	24
Diskette Drive	24
Hard Disk Drive	24
CD-ROM	25
Battery Pack	26
DC-DC/Charger Board	26
LCD Inverter	27
LCD	27
Power Adapter	28
Power Management	30
Power Management Modes	30
BIOS Setup Utility	33

Chapter 2 Software Utilities

Basic System Settings	34
---------------------------------	----

Table of Contents

Startup Configuration	35
Onboard Devices Configuration	36
System Security	37
Power Management	39
Load Default Settings	40
AFlash Utility	41
Executing AFlash	41
Quick Way to Execute AFlash	42
System Utility Diskette	43
Set LCD Panel ID	43
Set Thermal Sensor Threshold	43
System Diagnostic Diskette	44
Running PQA Diagnostics Program	45
Diagnostic Program Error Code and Messages	47

Chapter 3 Machine Disassembly

General Information	50
Before You Begin	50
Connector Types	50
Disassembly Procedure Flowchart	51
Removing the Battery Pack	53
Removing the DIMM	53
Removing the Modem Board	54
Removing the Keyboard	55
Removing the LCD Module	57
Disassembling the LCD	58
Disassembling the Main Unit	61
Removing the HDD & PCMCIA Heat Sink	61
Removing the Hard Disk Drive	61
Removing the CPU Heat Sink and CPU Board	62
Removing the RTC Battery	63
Disassembling the Upper Case	63
Removing the Touchpad	64
Disassembling the Lower Case	66
Removing the CD-ROM/Diskette Drive Module	66
Removing the Speakers	68
Removing the DC-DC/Charger Board	69
Removing the DC-DC/Charger Board	70
Removing the System Board	70

Removing the PCMCIA slot	71
Removing the Modem Phone Jack.	71

Chapter 4 Troubleshooting

System Check Procedures	74
Diskette Drive Check	74
CD-ROM Drive Check	74
Keyboard or Auxiliary Input Device Check	75
Memory Check	75
Power System Check	75
Touchpad Check	77
Error Symptom-to-FRU Index.	78
Error Messages List	78
No-Beep Symptoms	80
LCD-Related Symptoms.	81
Indicator-Related Symptoms	82
Power-Related Symptoms	82
PCMCIA-Related Symptoms	83
Memory-Related Symptoms.	83
Speaker-Related Symptoms.	83
Power Management-Related Symptoms	84
Peripheral-Related Symptoms	85
Keyboard/Touchpad-Related Symptoms	85
Intermittent Problems	86
Undetermined Problems.	86
Modem-Related Symptoms	86

Chapter 5 Connectors and Jumpers

SW1 Settings	90
SW2 Settings	90
Spare Parts List (P/N:91.45BXX.XXX)	91

Chapter 6 Spare Parts List

Model Number Definitions	101
------------------------------------	-----



Appendix A Model Definitions

Appendix B Compatibility Tested Components



System Introduction

This computer was designed with the user in mind. Here are just a few of its many features:

Performance

- ❑ Intel Pentium® processor with MMX™ technology
- ❑ 512-KB, 64-bit main memory and external (L2) cache memory
- ❑ Large LCD display and PCI local bus video with 128-bit graphics acceleration
- ❑ Internal CD-ROM drive
- ❑ Internal 3.5-inch floppy drive
- ❑ High-capacity, Enhanced-IDE removable hard disk
- ❑ Nickel metal-hydride battery pack
- ❑ Heuristic power management system with standby and hibernation power saving modes

Multimedia

- ❑ ISA-based 16-bit high-fidelity stereo audio with 3-D sound and wavetable synthesizer
- ❑ Built-in dual speakers
- ❑ “No power-on” audio CD playback
- ❑ Ultra-slim, high-speed CD-ROM drive

Connectivity

- ❑ High-speed fax/data modem port
- ❑ USB (Universal Serial Bus) port

Human-centric Design and Ergonomics

- ❑ Lightweight and slim
- ❑ Sleek, smooth and stylish design
- ❑ Full-sized keyboard
- ❑ Wide and curved palm rest
- ❑ Ergonomically-centered touchpad pointing device

Expansion

- ❑ CardBus PC card (formerly PCMCIA) slots (two type II/I or one type III), upper sort with additional ZV (Zoomed Video) port support.
- ❑ Mini docking station option for one-step connection to/disconnection

from peripherals

- Upgradeable memory and hard disk

Display

The large graphics display offers excellent viewing, excellent display quality and high performance desktop graphics. The computer supports two different display configurations — High Performance Addressing (HPA) or Thin-Film Transistor (TFT).

Video Performance

The PCI local bus video with 128-bit graphics acceleration and 2MB Extended Data Out (EDO) video RAM boosts video performance.

Simultaneous Display

The computer's large display and multimedia capabilities are great for giving presentations. If you prefer, you can also connect an external monitor when giving presentations. This computer supports simultaneous LCD and CRT display. Simultaneous display allows you to control the presentation from your computer and at the same time face your audience. You can also connect other output display devices such as LCD projection panels for large-audience presentations.

Power Management

The power management system incorporates an “automatic LCD dim” feature that automatically decides the best settings for your display and at the same time conserves power. See “Power Management Modes” on page 30 for more information on power management features.

Opening and Closing the Display

To open the display, slide the display cover latch to the left and lift up the cover. Then tilt it to a comfortable viewing position. The computer employs a microcircuit that turns off the display (and enters standby mode) to conserve power when you close the display cover, and turns it back on when you open the display cover.

Note: *If an external monitor is connected, the computer turns off the display (but does not enter standby mode) when you close the display cover.*

To close the display cover, fold it down gently until the display cover latch clicks into place.





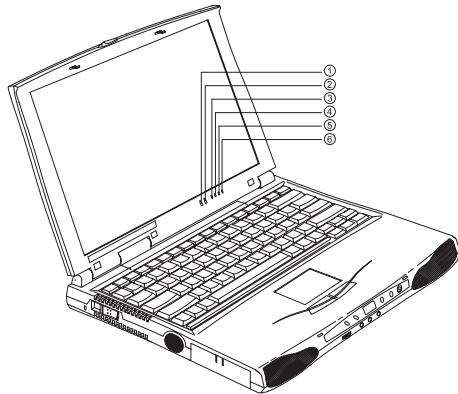

Basic Operation

Indicators

The computer has six easy-to-read status indicators (LEDs) under the display screen.



The Power and Standby indicators are visible even when you close the display cover so you can see the status of the computer while the cover is closed.

#	Icon	Function	Description
1		Power	Lights when the computer is on. Blinks when a battery-low condition occurs.
2		Standby	Lights when the computer enters Standby mode.
3		Media Activity	Lights when the floppy drive, hard disk or CD-ROM drive (or other media bay module) is active.
4		Battery Charge	Lights when the battery is being charged.
5		Caps Lock	Lights when Caps Lock is activated
6		Num Lock	Lights when Numeric Lock is activated

Keyboard

The keyboard has full-sized keys and an embedded keypad, separate cursor keys, two Windows 98 keys and twelve function keys.

Special Keys

Lock Keys

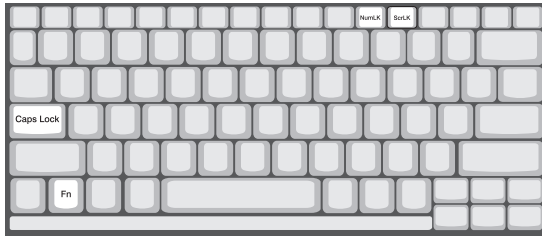

The keyboard has three lock keys which you can toggle on and off.

Lock Key	Description
Caps Lock	When Caps Lock is on, all alphabetic characters typed are in uppercase.
Num Lock (Fn-F11)	When Num Lock is on, the embedded keypad is in numeric mode. The keys function as a calculator (complete with the arithmetic operators +, -, *, and /). Use this mode when you need to do a lot of numeric data entry. A better solution would be to connect an external keypad.
Scroll Lock (Fn-F12)	When Scroll Lock is on, the screen moves one line up or down when you press \uparrow or \downarrow respectively. Scroll Lock does not work with some applications.

Embedded Numeric Keypad



The embedded numeric keypad functions like a desktop numeric keypad. It is indicated by small characters located on the upper right corner of the keycaps. To simplify the keyboard legend, cursor-control key symbols are not printed on the keys.

Desired Access	Num Lock On	Num Lock Off
Number keys on embedded keypad	Type numbers in a normal manner.	
Cursor-control keys on embedded keypad	Hold Shift while using cursor-control keys.	Hold Fn while using cursor-control keys.
Main keyboard keys	Hold Fn while typing letters on embedded keypad.	Type the letters in a normal manner.

Note: *If an external keyboard or keypad is connected to the computer, the numlock feature automatically shifts from the internal keyboard to the external keyboard or keypad.*

Windows 98 Keys







The keyboard has two keys that perform Windows 98-specific functions.

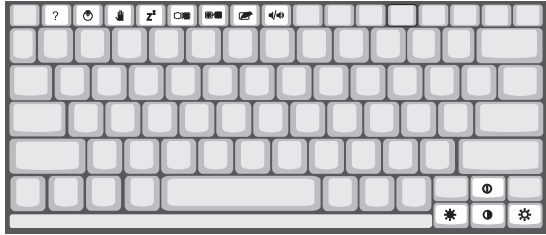





Key	Description
Windows logo key	Start button. Combinations with this key performs special functions. Below are a few examples: ⊞ + Tab (Activate next Taskbar button) ⊞ + E (Explore My Computer) ⊞ + F (Find Document) ⊞ + M (Minimize All) Shift + ⊞ + M (Undo Minimize All) ⊞ + R (Display Run dialog box)
Application key	Opens the application's context menu (same as right-click).

Hot Keys



The computer employs hot keys or key combinations to access most of the computer's controls like screen contrast and brightness, volume output and the BIOS setup utility.

Hot Key	Icon	Function	Description
Fn-F1	?	Hot key help	Displays a list of the hotkeys and their functions.
Fn-F2		Setup	Accesses the notebook configuration utility. .
Fn-F3		Standby	Puts the computer in Standby mode. Press any key to return. See "System Standby Mode" on page 30 to learn more about Standby mode.
Fn-F4	Z ^Z	Hibernation	Puts the computer in Hibernation mode (if Sleep Manager, the hibernation utility, is installed, valid and enabled). Press the power switch to resume. Otherwise, the computer enters Standby mode. See "Hibernation Mode" on page 31 for more about Hibernation mode.
Fn-F5		Display toggle	Switches display output between the display screen, external monitor (if connected) and both the display screen and external monitor.
Fn-F6		Screen blank	Turns the display screen backlight off to save power. Press any key to return.

Hot Key	Icon	Function	Description
Fn-F7		Touchpad on/off	Turns the internal touchpad on and off. When you connect an external PS/2 mouse, the computer automatically disables the touchpad.
Fn-F8		Speaker on/off	Turns the speakers on and off; mutes the sound.
Fn-↑		Contrast up	Increases the screen contrast (available only for models with HPA displays).
Fn-↓		Contrast down	Decreases the screen contrast (available only for models with HPA displays).
Fn-→		Brightness up	Increases the screen brightness.
Fn-←		Brightness down	Decreases the screen brightness.

Hardware Configuration and Specification

Memory Address Map

Memory Address	Size	Function
00000000-0009FFFF	640 KB	Base memory
000A0000-000BFFFF	128 KB	Video memory
000C0000-000C9FFF	40 KB	Video BIOS
000CA000-000CBFFF	8 KB	I/O ROM
000E0000-000FFFFF	128 KB	System BIOS
00100000-top limited	--	Extended (DIMM) memory
04301000-04301FFF	4 KB	PCMCIA controller (slot 1)
04302000-04302FFF	4 KB	PCMCIA controller (slot 2)
04300000-04300FFFF	64 KB	USB controller
FFFF0000-FFFFFFFF	64 KB	System board extension for PnP BIOS

Interrupt Channel Assignment

Interrupt Channel	Function
NMI	System errors
IRQ0	System timer
IRQ1	Keyboard
IRQ2	Cascade
IRQ3	Modem or Audio (optional)
IRQ4	COM1 or Modem (optional)
IRQ5	Audio or LPT2 (optional)
IRQ6	Floppy
IRQ7	LPT1 or Audio (optional) or Modem (optional)
IRQ8	Real time clock
IRQ9	Card bus / ACPI or Audio (optional)
IRQ10	USB or Audio (optional) or Modem (optional)
IRQ11	Audio (optional) or Modem (optional)
IRQ12	PS2 pointing device
IRQ13	Numeric data processor
IRQ14	1st EIDE device (hard disk)
IRQ15	2nd EIDE device (CD-ROM drive)

DMA Channel Assignment

DMA Channel	Function
DRQ0	Audio(optional)
DRQ1	ECP or Audio(optional)
DRQ2	Floppy
DRQ3	ECP(optional)
DRQ4	DMA controller
DRQ5	Not used
DRQ6	Not used
DRQ7	Audio

I/O Address Map

I/O Address	Function
000-00F	DMA controller-1
020-021	Interrupt controller-1
040-043	Timer 1
060, 064	Keyboard controller 8742 chip select
061	System speaker out
040B	DMA controller-1
061	System speaker
070-071	Real-time clock and NMI mask
080-08F	DMA page register
0A0-0A1	Interrupt controller-2
0C0-0DF	DMA controller-2
0F0-0FF	Numeric data processor
120-13F 180-18F	Power management controller
170-177	2nd EIDE device (CD-ROM) select
1F0-1F7	1st EIDE device (hard drive) select
220-22F	Audio
240-24F	Audio(optional)
278-27F	Parallel port 3
2E8-2EF	LT Win modem or COM4(optional)
2F8-2FF	COM2 or LT Win modem(optional)
378, 37A	Parallel port 2

I/O Address Map

I/O Address	Function
3BC-3BE	parallel port 1
3B0-3BB 3C0-3DF	Video Controller
3F0h-3F7	Standard Floppy Disk Controller
3E8-3EF	COM3 or LT Win modem(optional)
3F0-3F7	Floppy disk controller
3F8-3FF	COM1 or LT Win modem(optional)
480-48F, 4D6	DMA controller-1
4D0-4D1 CF8-CFF	PCI configuration register

Processor

Item	Specification
CPU type	Intel Tillamook 233/266 Mhz processor Tillamook--Intel Pentium architecture, 64 bit data bus, 16K-Byte code cache, 16 K-Bytes write back data, cache, with MMX technology
CPU package	TCP package
CPU core voltage	1.8V
CPU I/O voltage	2.5V

BIOS

Item	Specification
BIOS vendor	Acer
BIOS Version	V 3.0
BIOS ROM type	Flash ROM
BIOS ROM size	256KB
BIOS package	32-pin TSOP
Supports protocol	PCI 2.1, APM 1.2, DMI 2.00.1, E-IDE, ACPI, USB, ESCD 1.03, ANSI ATA 3.0, PnP 1.0a, Bootable CD- ROM 1.0, ATAPI, LDCM 3.3
BIOS password control	Set by switch, see SW2(swtich 2) settings

System Memory

Item	Specification
Memory controller	ALi M1531
Onboard memory size	0MB
DIMM socket number	2 sockets (2 banks)
Supports memory size per socket	16/32/64/128 MB
Supports maximum memory size	256MB (128MB x 2)
Supports DIMM type	Synchronous DRAM
Supports DIMM Speed	100MHz
Supports DIMM voltage	3.3V
Supports DIMM package	144-pin DIMM

DIMM Combinations

Slot 1	Slot 2	Total Memory
0	16MB	16MB
0	32MB	32MB
0	64MB	64MB
0	128MB	128MB
16MB	16MB	32MB
16MB	32MB	48MB
16MB	64MB	80MB
16MB	128MB	144MB
32MB	16MB	48MB
32MB	32MB	64MB
32MB	64MB	96MB
32MB	128MB	160MB
64MB	16MB	80MB
64MB	32MB	96MB
64MB	64MB	128MB
64MB	128MB	192MB
128MB	16MB	144MB
128MB	32MB	160MB
128MB	64MB	192MB
128MB	128MB	256MB

Video Memory

Item	Specification
Fixed or upgradeable	Fixed, built-in NM2097B video controller
Video memory size	2MB

Cache Memory

Item	Specification
Cache controller	ALi M1531
Tag RAM location	U32
Tag RAM size	32 KB
Tag RAM voltage	3.3V
SRAM type	PBSRAM
SRAM size	512 KB
SRAM location	U37
SRAM configuration	64K*64 x1
SRAM speed	Cycle time = 7ns
SRAM voltage	3.3V
1st level cache control	Always enabled
2st level cache control	Always enabled
Cache scheme control	Fixed in write-back

Video

Item	Specification
Chip vendor	NeoMagic
Chip name	NM2097B
Chip voltage	3.3 Volts
Supports ZV((Zoomed Video) port	Yes
Graph interface (ISA/VESA/PCI)	PCI bus
Maximun resolution (LCD)	1024x768 (256 colors)
Maximnun resolution (CRT)	1024x768 (256 colors)

Video Resolutions Modes

Resolution	Refresh Rate
	CRT Only LCD/CRT Simultaneous

Video Resolutions Modes

Resolution	Refresh Rate	
640x480x256	85	60
640x480x64K	85	60
640x480x16M	85	60
800x600x256	85	60
800X600X64K	85	60
1024x768x256	60, 75	60

Parallel Port

Item	Specification
Parallel port controller	NS PC97338VJG
Number of parallel ports	1
Location	Rear side
Connector type	25-pin D-type connector, in female type.
Parallel port function control	Enable/Disable by BIOS Setup
Supports ECP	Yes (set by BIOS setup)
Optional ECP DMA channel (in BIOS Setup)	DMA channel 1 DMA Channel 3
Optional parallel port I/O address (in BIOS Setup)	3BCh, 378h, 278h
Optional parallel port IRQ (in BIOS Setup)	IRQ5, IRQ7

Serial Port

Item	Specification
Serial port controller	NS PC97338VJG
Number of serial ports	1
Supports 16550 UART	Yes
Connector type	9-pin D-type connector, in male type
Location	Rear side
Serial port function control	Enable/disable by BIOS Setup
Optional serial port (in BIOS Setup)	3F8h, 2F8h, 3E8h, 2E8h, Disabled
Optional serial port IRQ (in BIOS Setup)	IRQ4, IRQ11

Audio

Item	Specification
Audio Controller	Yamaha YMF715E
Audio onboard or optional	Built-in
Mono or Stereo	Stereo
Resolution	16-bit
Compatibility	SB-Pro, Windows Sound System (WSS), MPU-401, OPL3, OPL3-SA3
Mixed sound source	Voice, Synthesizer, Line-in, Microphone, CD
Voice channel	8-/16-bit, mono/stereo
Sampling rate	44.1 KHz
Internal microphone	Yes, on the left-higher corner of LCD panel
Internal speaker / Quantity	Yes / 2 pieces, on both hinge sides
Supports PnP DMA channel	DMA channel 0 DMA channel 1 DMA channel 7
Supports PnP IRQ	IRQ3, IRQ5, IRQ7, IRQ9, IRQ10, IRQ11

PCMCIA

Item	Specification
PCMCIA controller	O2 OZ6833T
Supports card type	Type-II / type-III
Number of slots	Two type-II or one type-III
Access location	Right side
Supports ZV (Zoomed Video) port	Yes (for upper slot)
Supports 32 bit CardBus	Yes (IRQ9, for both slots)

Modem

Item	Specification
Chipset	Lucent 1641B
Fax modem data baud rate (bps)	56K
Data modem data baud rate (bps)	56K

Modem

Item	Specification
Supports modem protocol	V.90 data modem, V.90 fax modem, audio mode, and digital line protection operation
Modem connector type	RJ11
Modem connector location	Right side

Keyboard

Item	Specification
Keyboard controller	Mitsubishi M38867
Keyboard vendor & model name	API
Total number of keypads	84-/85-/89-key
Windows 95 keys	Yes
Internal & external keyboard work simultaneously	Yes

Diskette Drive

Item	Specification		
Vendor & model name	Misumi D353F3		
Floppy Disk Specifications			
Media recognition	2DD (720KB)	2HD (1.2MB, 3-mode)	2HD (1.44MB)
Sectors / track	9	15	18
Tracks	80	80	80
Data transfer rate (Kbit/s)	250 ~ 300	500	500
Rotational speed (RPM)	300 ~ 360	360	300
Read/write heads	2		
Encoding method	MFM		
Power Requirement			
Input Voltage (V)	+5 +10%		

Hard Disk Drive

Item	Specification		
Vendor & Model Name	Hitachi DK226A-32u	IBM DTCA-23240	IBM DKLA-24320

Hard Disk Drive

Item	Specification		
Drive Format			
Capacity (MB)	3240	3240	4320
Bytes per sector	512	512	512
Logical heads	16	16	15
Logical sectors	63	63	63
Drive Format			
Logical cylinders	6282	6304	8944
Physical read/write heads	3	5	4
Disks	6	3	2
Spindle speed (RPM)	4000	4000	4200
Performance Specifications			
Buffer size	128KB	512KB	512KB
Interface	IDE(ATA-3)	IDE	IDE(ATA-4)
Data transfer rete (disk-buffer, Mbytes/s)	6.0~9.1	6.4~10.4	7.7~12.8
Data transfer, rate (host-buffer, Mbytes/s)	16.6 (PIO mode 4)	16.6 (PIO mode 4) 33.3 (Ultra DMA mode 2)	
DC Power Requirements			
Voltage tolerance	5+-5%	5+-5%	5+-5%

CD-ROM

Item	Specification
Vendor & Model Name	TEAC CD-220EA-25/BE
Performance Specification	
Transfer rate (KB/sec)	1,290KB/sec ~ 3,000KB/sec. (FULL - CAV)
Access time (typ.)	180 mS
Rotation speed	4280 rpm (typ.)
Buffer memory	128 KB
Interface	ATAPI
Applicable disc format	CD-DA, CD-ROM (Mode-1, Mode-2), CD-ROM XA MODE-2 (FORM-1, FORM-2), Multi-Session Photo CD, CD-I, Video CD, Enhanced CD & CD PLUS Compatible
Loading mechanism	Drawer with soft eject and emergency eject hole
Power Requirement	

CD-ROM

Item	Specification
Input Voltage	5 V

Battery Pack

Item	Specification
Vendor & model name	Panasonic BTP-1831 Toshiba BTP-1731
Battery Type	NiMH
Pack capacity	3500 mAH
Cell voltage	1.2 V
Number of battery cell	8
Package configuration	8 cells in series
Package voltage	9.6 V

DC-DC/Charger Board

Item	Specification				
Vendor & model name	Ambit T62.101.C.00/01				
Input voltage	AC adapter: 19V-26V Battery: 7.5V-13V				
DC/DC converter output					
Output rating	5V	3.3V	+12V	6V	3.3V SB
Current (w/load, A)	0~5.8	0~3.3	0~0.12	0~0.1	0.01
Charger output					
Normal charge (charge while system is not operative)	2.2A				
Background charge (charge even system is still operative)	0.8A				
Battery-lower 2 level (V)	9.14V				
Battery-low 3 level (V)	8V				
Protection					
Charger protection	Security timer control Over temperature protection Peak voltage detection				
DC/DC converter protection	OVP (Over Voltage Protection, V) OCP (Over Current Protection, A)				

LCD Inverter

Item	Specification		
Vendor & model name	Ambit T622.087.C.00		
Input voltage (V)	7.3 (min.)	-	22 (max.)
Input current (mA)	-	-	700 (max.)
Output voltage (Vrms, no load)	1300 (min.)	155	1600 (max.)
Output voltage frequency (kHz)	40 (min.)	-	65 (max.)
Output current (mArms) (T62.087.C.00)	0.7~5.9 (min.)	1.0~6.5 (typ.)	1.3~7.1 (max.)
Output current (mArms) (T62.086.C.00)	0.6~5.4 (min.)	1.0~6.0 (typ.)	1.4~6.6 (max.)

Note: DC-AC inverter is used to generate very high AC voltage, then support to LCD CCFT backlight user, and is also responsible for the control of LCD brightness. Avoid touching the DC-AC inverter area while the system unit is turned on.

Note: There is an EEPROM in the inverter, which stores its supported LCD type and ID code. If you replace a new inverter or replace the LCD with one of a different brand, use Inverter ID utility to update the ID information.

LCD

Item	Specifications	
Vendor & model name	12.1" Hitachi TX31D27VC1CBB	12.1" Sharp LM121SS1T53
Mechanical Specifications		
LCD display area (diagonal, inch)	12.1	12.1
Display technology	TFT	DSTN
Resolution	SVGA (800x600)	SVGA (800x600)
Supports colors	262,144 colors	262,144 colors
Optical Specification		
Brightness control	keyboard hotkey	keyboard hotkey
Contrast control	keyboard hotkey	keyboard hotkey

LCD

Item	Specifications	
Electrical Specification		
Supply voltage for LCD display (V)	3.0~3.6 (typ.)	3.3 (typ.)
Supply voltage for LCD backlight (Vrms)	650 (typ), 660 (max.)	650 (typ)

Power Adapter

Item	Specification
Vendor & model name	Delta ADP-45GB Rev. E5
Input Requirements	
Maximum input current (A, @90Vac, full load)	1.5 A
Nominal frequency (Hz)	47 - 63
Frequency variation range (Hz)	47 - 63
Nominal voltages (Vrms)	90 - 264
Inrush current	The maximum inrush current will be less than 50A and 100A when the adapter is connected to 115Vac(60Hz) and 230Vac(50Hz) respectively.
Efficiency	It should provide an efficiency of 83% minimum, when measured at maximum load under 115V(60Hz).
Output Ratings (CV mode)	
DC output voltage	+19.0V~20.5V
Noise + Ripple	300mvp-pmax (20Mhz bandwidth)
Load	0 A (min.) 2.4 A (max.)
Output Ratings (CC mode)	
DC output voltage	+12V ~ +19V
Constant output	2.75 ± 0.2 A
Dynamic Output Characteristics	
Turn-on delay time	2 sec. (@115Vac)
Hold up time	5 ms min. (@115 Vac input, full load)
Over Voltage Protection (OVP)	26 V
Short circuit protection	Output can be shorted without damage
Electrostatic discharge (ESD)	15kV (at air discharge)
Dielectric Withstand Voltage	

Power Adapter

Item	Specification
Primary to secondary	3000 Vac (or 4242 Vdc), 10 mA for 1 second
Leakage current	0.25 mA max. (@ 254 Vac, 60Hz)
Regulatory Requirements	Internal filter meets: 1. FCC class B requirements. (USA) 2. VDE 243/1991 class B requirements. (German) 3. CISPR 22 Class B requirements. (Scandinavia) 4. VCCI class II requirements. (Japan)

Power Management

This computer has a built-in power management unit that monitors system activity. System activity refers to any activity involving one or more of the following devices: keyboard, mouse, floppy drive, hard disk, peripherals connected to the serial and parallel ports, and video memory. If no activity is detected for a period of time (called an inactivity time-out), the computer stops some or all of these devices in order to conserve energy.

This computer manages its power according to the way you use your computer. This means the computer delivers maximum power when you need it, and saves power when you don't need the maximum — all without your intervention. There are no timers to set, because the power management system figures out everything for you.

Power Management Modes

Display Standby Mode

Screen activity is determined by the keyboard the built-in touchpad, and an external PS/2 pointing device. If these devices are idle for the period determined by the computer's power management system, the display shuts off until you press a key or move the touchpad or external mouse.

“Automatic Dim” Feature

The computer has a unique “automatic dim” power-saving feature. When the computer is using AC power and you disconnect the AC adapter from the computer, it automatically dims the LCD backlight to save power. If you reconnect AC power to the computer, it automatically adjusts the LCD backlight to a brighter level.

Hard Disk Standby Mode

The hard disk enters standby mode when there are no disk read/write operations within the period of time determined by the power management system. In this state, the power supplied to the hard disk is reduced to a minimum. The hard disk returns to normal once the computer accesses it.

System Standby Mode

The computer consumes very little power in Standby mode. Data remain intact in the system memory until the battery is drained.

There is one necessary condition for the computer to enter Standby mode:

- Heuristic Power Management Mode must be set to [ENABLED].

There are four ways to enter Standby mode:

-
- ❑ Pressing the Standby hot key Fn-F3
 - ❑ If the waiting time determined by the computer's power management system elapses without any system activity
 - ❑ Closing the display cover
 - ❑ When the computer is about to enter Hibernation mode (e.g., during a battery low condition), but the Hibernation file is invalid or not present

The following signals indicate that the computer is in Standby mode:

- ❑ The Standby indicator lights

To leave Standby mode and return to normal mode:

- ❑ Press any key
- ❑ Move the active pointing device (internal or external, PS/2 or serial)
- ❑ Have the Resume Timer set and let it be matched
- ❑ Open the display cover
- ❑ Experience an incoming PC card modem event

Hibernation Mode

In Hibernation mode, all power shuts off (the computer does not consume any power). The computer saves all system information onto the hard disk before it enters Hibernation mode. Once you turn on the power, the computer restores this information and resumes where you left off upon leaving Hibernation mode.

There are two necessary conditions for the computer to enter Hibernation mode:

- ❑ The Hibernation file created by Sleep Manager must be present and valid.
- ❑ Heuristic Power Management Mode must be set to [ENABLED].

In this situation, there are four ways to enter Hibernation mode:

- ❑ Pressing the Hibernation hot key Fn-F4
- ❑ If the waiting time determined by the computer's power management system elapses without any system activity
- ❑ If a battery low condition occurs and the Battery Low Suspend parameter in Setup is set to [ENABLED].
- ❑ Invoked by the operating system power saving modes
- ❑ To exit Hibernation mode, press the power switch. The computer also resumes from Hibernation mode if the resume timer is set and matched.

Software Utilities

BIOS Setup Utility

The BIOS Setup Utility is a hardware configuration program built into your computer's BIOS (Basic Input/Output System).

Your computer is already properly configured and optimized, and you do not need to run this utility. However, if you encounter configuration problems, you may need to run Setup. Please also refer to Chapter 6, Troubleshooting when a problem arises.

To activate the BIOS Utility, press **F2** during POST (while the Extensa logo is being displayed).

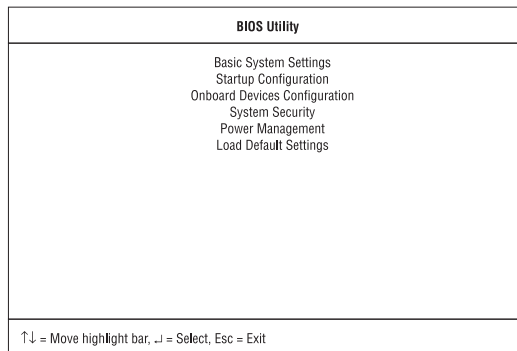

Navigating the BIOS Utility

There are six menu options: Basic System Settings, Startup Configuration, Onboard Devices Configuration, System Security, Power Management and Load Default Settings.

To enter a menu, highlight the item using the ↑↓ keys; then press **Enter**.

Within a menu, navigate through the BIOS Utility by following these instructions:

- ❑ Press the cursor up/down keys ↑↓ to move between parameters.
- ❑ Press the cursor left/right keys →← to change the value of a parameter.
- ❑ Press **Esc** while you are in any of the menu options to return to the main menu.

Note: You can change the value of a parameter if it is enclosed in

square brackets.

Note: Navigation keys for a particular menu are shown on the bottom of the screen.

Basic System Settings

The Basic System Settings screen contains parameters involving basic computer settings and hardware information.

Basic System Settings		Page 1/1
Date -----	[Tue Jun 2 1998]	
Time -----	[17:49:00]	
Floppy Drive A -----	[1.44MB 3.5-inch]	
Hard Disk -----	[Auto]	
	Cylinder Head Sector Size(MB)	
	6304 16 63 3102	

↑↓ = Move highlight bar, ←→ = Change setting, F1 = Help

The following table describes the parameters in this screen. Settings in boldface are the default and suggested parameter settings.

Parameter	Description
Date	Sets the system date. Format: DDD MMM DD YYYY (day-of-the-week month day year)
Time	Sets the system time. Format: HH:MM:SS (hour:minute:second)
Floppy Drive A	Shows the floppy disk drive type (1.44MB 3.5-inch).
Hard Disk	Sets the hard disk type. Options: Auto , User or None. When set to Auto, the computer automatically detects the hard disk information (cylinders, heads, sectors/ tracks and maximum capacity). When set to User, you need to input these information manually.

Note: We suggest you set Hard Disk to [Auto] for problem-free and correct detection of the hard disk.

Startup Configuration

The Startup Configuration screen contains parameters that are related to computer startup.

Startup Configuration		Page 1/1
Boot Display -----	[Both]	
Memory Test -----	[Disabled]	
Silent Boot -----	[Enabled]	
System Boot Drive -----	[Drive A Then C]	
Boot from CD-ROM -----	[Enabled]	
Operating System -----	[Windows 95/98]	
USB Function Support -----	[Disabled]	

↑↓ = Move highlight bar, ←→ = Change setting, F1 = Help

The following table describes the parameters in this screen. Settings in boldface are the default and suggested parameter settings.

Parameter	Description
Boot Display	Sets the display on boot-up. When set to Auto, the computer automatically determines the display device. If an external display device (e.g., monitor) is connected, it becomes the boot display; otherwise, the computer LCD is the boot display. When set to Both, the computer outputs to both the computer LCD and an external display device if one is connected. Options: Auto or Both
Memory Test	Enables or disabled memory test on boot-up. Options: Disabled or Enabled
Silent Boot	When enabled, hides the computer startup messages on boot-up (the Extensa logo displays) Options: Enabled or Disabled
System Boot Drive	Specifies the boot sequence (the order of drives that the computer will attempt to boot from). For example, when set to Drive A Then C, the computer attempts to boot from the floppy drive. If no bootable floppy disk is in drive A, the computer boots from the hard disk. Options: Drive A Then C , Drive A, Drive C, Drive C Then A

Parameter	Description
Boot from CD-ROM	Enables boot-up from the CD-ROM drive. When enabled, the computer attempts to boot from the CD-ROM drive (looks for a bootable CD-ROM) before following the boot sequence specified in the System Boot Drive parameter. Options: Enabled or Disabled
Operating System	Specifies the operating system installed in the computer. This parameter helps determine certain hardware settings for optimal computer operation. Options: Windows 95/98 or Windows NT
USB Function Support	Enables or disables the USB (Universal Serial Bus) function. Options: Disabled or Enabled

Onboard Devices Configuration

The Onboard Devices Configuration screen contains parameters settings for your hardware connection devices.

Onboard Devices Configuration		Page 1/1
Serial Port	[Enabled]	
Base Address	[3F8h]	
IRQ	[4]	
Parallel Port	[Enabled]	
Base Address	[378h]	
IRQ	[7]	
Operation Mode	[Bi-directional]	
ECP DMA Channel	[-]	

↑↓ = Move highlight bar, ←→ = Change setting, F1 = Help

Note: *The parameters in this screen are for advanced users only. You do not need to change the values in this screen because these values are already optimized.*

The following table describes the parameters in this screen. Settings in boldface are the default and suggested parameter settings.

Parameter	Description
Serial Port	Enables or disabled the serial port. Options: Enabled or Disabled

Parameter	Description
Base Address	Sets the I/O address of the serial port. Options: 3F8h , 2F8h, 3E8h or 2E8h
IRQ	Sets the interrupt request of the serial port. Options: 4 or 11
Parallel Port	Enables or disables the parallel port. Options: Enabled or Disabled
Base Address	Sets the I/O address of the parallel port. Options: 378h , 278h or 3BCh
IRQ	Sets the interrupt request of the parallel port. Options: 7 or 5
Operation Mode	Sets the operation mode of the parallel port. Options: Bi-directional , ECP or Standard
ECP DMA Channel	Sets a DMA channel for the printer to operate in ECP mode. This parameter is enabled only if Operation Mode is set to ECP. Options: 1 or 3

System Security

The System Security screen contains parameters that help safeguard and protect your computer from unauthorized use.

System Security		Page 1/1
Disk Drive Control		
Diskette Drive -----	[Normal]
Hard Disk Drive -----	[Normal]
Setup Password -----	[None]
Power-on Password -----	[None]
↑↓ = Move highlight bar, ←→ = Change setting, F1 = Help		

The following table describes the parameters in this screen. Settings in boldface are the default and suggested parameter settings.

Parameter	Description
Disk Drive Control (Diskette Drive)	Determines the level of operation of the floppy drive. Options: Normal or Disabled
Disk Drive Control (Hard Disk Drive)	Determines the level of operation of the hard disk. Options: Normal or Disabled
Setup Password	When set, this password protects the BIOS Utility from unauthorized entry. Options: None or Present
Power-on Password	When set, this password protects the computer from unauthorized entry during boot-up or resume from hibernation mode. Options: None or Present

Setting a Password

Follow these steps:

1. Use the **↑** and **↓** keys to highlight a password parameter (Setup or Power-on) and press the **Enter** key. The password box appears:

2. Type a password. The password may consist of up to seven characters (A-Z, a-z, 0-9).

Note: *Be very careful when typing your password because the characters do not appear on the screen.*

3. Press **Enter**. The retype password box appears.

4. Retype the password to verify your first entry and press **Enter**.
5. After setting the password, the computer automatically sets the chosen password parameter to Present.
6. Press **Esc** to return to the main menu.
7. Press **Esc**. The following dialog box appears.

Settings have been changed.
Do you want to save CMOS settings?

[Yes] [No]

Select **Yes** and press **Enter** to save the password and exit the BIOS Utility.

Changing a Password

To change a password, follow the same steps used to set a password.

Removing a Password

To remove a password, use the ↑ and ↓ keys to highlight a password parameter and press the ← or → key.

Power Management

The Power Management screen contains parameters that are related to power-saving and power management.

Power Management		Page 1/1
Heuristic Power Management Mode	-----	[Enabled]
Display Always On	-----	[Disabled]
Hotkey Beep	-----	[Enabled]
System Resume Timer Mode	-----	[Disabled]
System Resume Date	-----	[--:--]
System Resume Time	-----	[--:--]
Battery-low Warning Beep	-----	[Enabled]
Sleep Upon Battery-low	-----	[Enabled]

↑↓ = Move highlight bar, ←→ = Change setting, F1 = Help

The following table describes the parameters in this screen. Settings in boldface are the default and suggested parameter settings.

Parameter	Description
Heuristic Power Management Mode	Enables or disables heuristic power management (Windows 95 only). See "Power Management" on page 30 for more information on power management modes. Options: Enabled or Disabled
Display Always On	When enabled, the computer display is always on (Windows 95 only). You may want to set this if you are making a presentation on your computer. Options: Disabled or Enabled
Hotkey Beep	When enabled, the computer gives off a beep when a hot key (key combination is pressed). See "Hot Keys" on page 15 for details on hot keys. Options: Enabled or Disabled

Parameter	Description
System Resume Timer Mode	When enabled and the system resume date and time are valid, the computer resumes (wakes up) at the set time and date. Options: Disabled or Enabled
System Resume Date	Sets the date the computer resumes at if System Resume Timer Mode is enabled. Format: MM DD, YYYY (month day, year)
System Resume Time	Sets the time the computer resumes at if System Resume Time Mode is enabled. Format: HH:MM:SS (hour:minute:second)
Battery-Low Warning Beep	Enables or disables warning beeps during a battery-low condition. Options: Enabled or Disabled
Sleep on Battery-low	Enables or disables the hibernation function during a battery-low condition. When the computer is running very low on battery power, the computer will enter hibernation mode if Sleep Manager is installed and the hibernation file is valid. Options: Enabled or Disabled

Load Default Settings

When you select this menu item, the following dialog box displays:

Do you want to load default settings?

[Yes] [No]

To load factory-default settings for all the parameters, select **Yes** and press **Enter**. Otherwise, select **No** and press **Enter**.

AFlash Utility

The BIOS flash memory update is required for the following conditions:

- ❑ New versions of system programs
- ❑ New features or options

Use the AFlash utility to update the system BIOS flash ROM.

Note: *Do not install memory-related drivers (XMS, EMS, DPMS) when you use AFlash.*

The AFlash functions support all the operations required for system Flash ROM. The functions are divided into four steps as follows.

1. **Load BIOS file to buffer** reads a specified file from a diskette to memory for future program use or for check only. It supports the 64-KB, 128-KB, 192-KB, or 256-KB files.
2. **Save BIOS to disk file** reads BIOS from the current BIOS area and writes to the file specified by the user.
3. **Edit OEM string** reads specified file from a diskette to memory, edits OEM string and writes to a file.
4. **Program flash memory** programs Flash memory according to the data loaded in step 1. This function also shows the BIOS checksum and BIOS type to make sure that the operation is correct.

Executing AFlash

Follow these steps to execute AFlash:

1. Copy the MSG.DAT and AFLASH.EXE files from the system utilities diskette into the subdirectory of your choice.
2. From that subdirectory, type:
aflash **Enter**
3. A help message appears. Press any key to continue.
4. The main menu appears. Use the ↑ or ↓ key to highlight the options. Press **Enter** to select.
5. If you want to save a copy of the current BIOS into a file, select **Save BIOS to Disk File**.
6. Select **Load BIOS File** to load the BIOS file into memory.
7. Select **Program Flash Memory** to erase the current BIOS, and program Flash ROM.

Note: *Never turn off the system power while Flash BIOS is programming. This will destroy the BIOS.*

8. Reboot the system.

Quick Way to Execute AFlash

When you have already copied the AFlash files into your hard disk, you can simply type the following on the DOS prompt (subdirectory where the files are located) to quickly execute the program.

aflash (file name) **Enter**

The program automatically performs the loading and programming functions, then reboots the system.

If the program cannot find the BIOS file, it returns to the main menu and flashes the following message:

Can't Read This File!!! Press any key to continue.....

In this case, follow the procedures for loading and programming the BIOS file using the main menu.

System Utility Diskette

1. This utility diskette is for the Acer Extensa 500 notebook machine. It provides the following functions:
2. Read/write LCD panel ID
3. Set thermal sensor threshold
4. Verify thermal sensor threshold (by testing fan function)

To use this diskette, first boot from this diskette, then a "Microsoft Windows 95 Startup Menu" prompt you to choose the testing item. Follow the instructions on screen to proceed.

Important!! This diskette is not bootable, do the following actions before you use it:

1. Do system transfers.
2. Copy HIMEM.SYS to A:\.
3. Copy HIMEM.COM to A:\.

Set LCD Panel ID

There is an EEPROM in the inverter which stores its supported LCD type ID code. If you replace a LCD with one of a different brand or use a new inverter, the ID information in the inverter EEPROM should be updated.

Follow the steps below to see the LCD Panel ID:

1. Follow the instruction on screen to read current or to set new LCD Panel ID code.

Note: *When you set a new LCD Panel ID and the new LCD is not yet enabled (to function), so connect an external CRT to see the program execution process.*

Note: *Make sure the new ID code you choose corresponds with the LCD brand and type. If you write a wrong ID into inverter, just reboot and re-execute the program and input the correct ID code.*

2. Restart computer - the new LCD should work normally.

Note: *If LCD cannot display after change ID code, make sure you write the correct ID code, or try reconnecting the LCD FPC cable connectors.*

Set Thermal Sensor Threshold

The system is equipped with sensors to protect against system overheating. By setting System and processor thermal thresholds, the system can turn on the cooling fan or shut down automatically when temperatures reach the defined threshold parameters.

System Diagnostic Diskette

This diagnostic diskette is for the Acer Extensa 500 notebook machine. It provides the following functions:

1. System Test
2. Modem Dialing Test

Note: *A phone line is required when executing the Modem Dialing Test, or this test fails.*

3. Audio Function Test
4. CD-Player Function Test
5. USB Register and Connect/Disconnect Test

Note: *A USB device is required when executing USB Connection/ Disconnection Test, or this test fails.*

To use this diskette, first boot from this diskette, then a "Microsoft Windows 95 Startup Menu" prompts you to choose the testing item. Follow the instructions on screen to proceed.

Important!! This diskette is not bootable, do the following actions before you use it:

1. Do system transfers.
2. Copy the following files to A:\
HIMEM.SYS
EMM386.SYS
MSCDEX.SYS
CHOICE.COM
RAMDRIVE.SYS

Note: *When executing a parallel or serial port test in System Test item, a loopback tool is needed. This loopback is Acer proprietary design. You may reach the computerhwdoctor@acer.com.tw for ordering information.*

Running PQA Diagnostics Program.

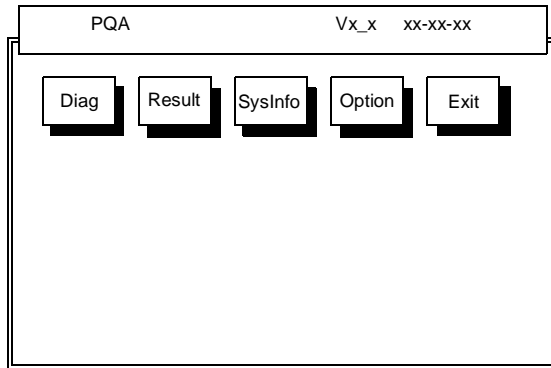

Press →← to move around the main menu. Press Enter to enable the selected option. The main options are Diag, Result, SysInfo, Option and Exit.

The Diag option lets you select testing items and times.

The following screen appears when you select Diag from the main menu.

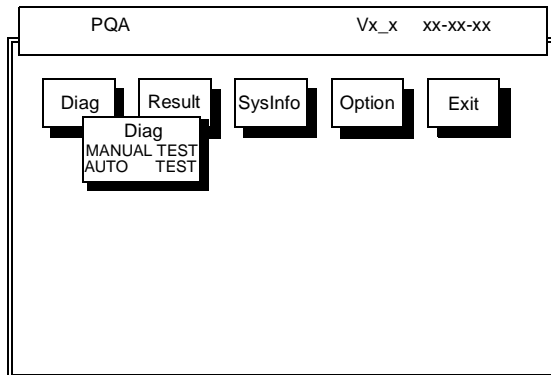

Manual Test Performs a single test and Manual checks the selected test items in sequence.

Auto Test Performs multiple tests of the selected items and AUTO check the select test items in sequence.

Note: *PCMCIA Diagnostic Supports Manual test only. Do not select PCMCIA Diagnostic in Auto Test.*

The screen below appears if you select AUTO Test.

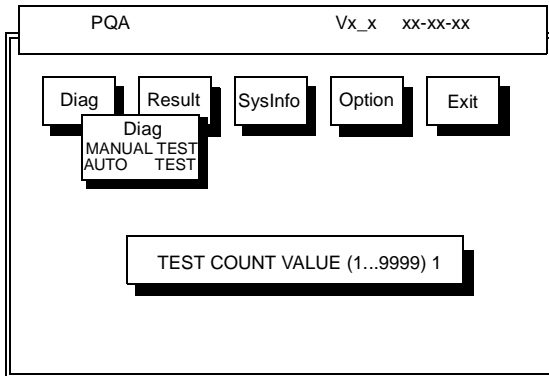

Specify the desired number of tests and press **Enter**.

After you specify the number of tests to perform, the screen shows a list of test items (see below).

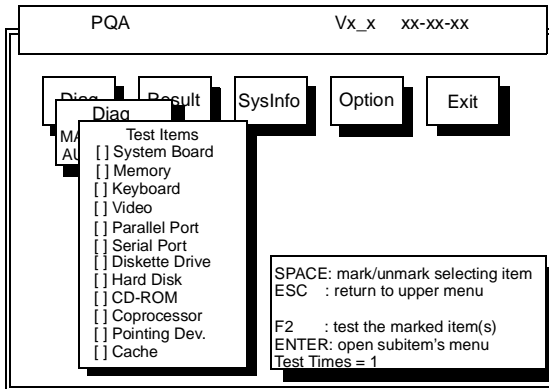

Move the highlight bar from one item to another. Press Space to enable or disable the item. Press **Enter** to view the available options of each selected item. Press **Esc** to close the submenu.

The right corner screen information gives you the available function keys and the specified test number.

- Space: Enables/disables the item
- ESC: Exits the program
- F1: Help
- F2: Tests the selected item(s)
- Enter: Opens the available options

- Test Times: Indicates the number of tests to perform.

Note: *The F1 and F2 keys function only after you finish configuring the Test option.*

Diagnostic Program Error Code and Messages

Error Code	Message	FRU/Action in Sequence
16XX	Backup battery error	Backup battery
1XXX	CPU or main board error	Reload BIOS default setting. CPU System board
2XXX	Memory error	Reconnect CPU board DIMM System board
3XXX	Keyboard error	Reseat Keyboard Keyboard System board
4XXX	Video error	System board
5XXX	Parallel Port error	System board
6XXX	Serial port or main board error	System board
7XXX	Diskette drive error	Diskette drive System board
8XXX	Hard disk error	Reload BIOS default setting. Hard disk System board
9XXX	CD-ROM error	Reseat CD-ROM cable CD-ROM drive System board
10XXX	CPU or main board error	CPU System board
11XXX	Pointing device error	Reseat Keyboard Keyboard System board

Machine Disassembly

This chapter contains step-by-step procedures on how to disassemble the notebook computer for maintenance and troubleshooting.

To disassemble the computer, you need the following tools:

- ❑ Wrist grounding strap and conductive mat for preventing electrostatic discharge
- ❑ Flat-bladed screwdriver
- ❑ Phillips screwdriver
- ❑ Tweezers
- ❑ Flat-bladed screwdriver or plastic stick

Note: *The screws for the different components vary in size. During the disassembly process, group the screws with the corresponding components to avoid mismatch when putting back the components.*

General Information

Before You Begin

Before proceeding with the disassembly procedure, make sure that you do the following:

1. Turn off the power to the system and all peripherals.
2. Unplug the AC adapter and all power and signal cables from the system.
3. Remove the battery pack.

Connector Types

There are two kinds of connectors on the system board:

- ❑ Connectors with no locks
Unplug the cable by simply pulling out the cable from the connector.
- ❑ Connectors with locks
You can use a plastic stick to lock and unlock connectors with locks.

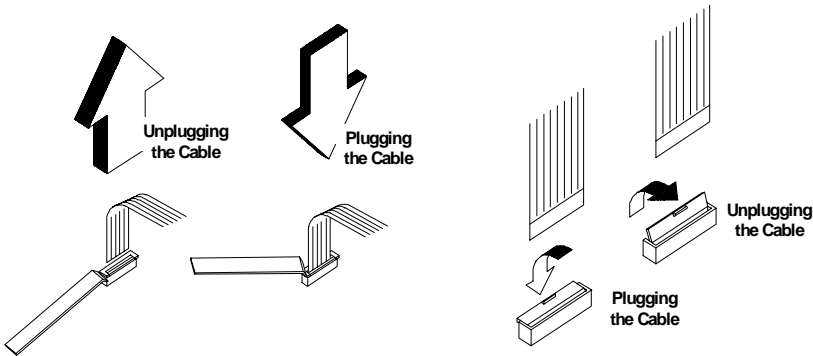

Unplugging the cable with locks

To unplug the cable, first unlock the connector by pulling up the two clasps on both sides of the connector with a plastic stick. Then carefully pull out the cable from the connector.

Plugging the cable with locks

To plug the cable back, first make sure that the connector is unlocked, then plug the cable into the connector. With a plastic stick, press the two clasps on both sides of the connector to secure the cables in place.

Note: *The cables used here are special FPC (flexible printed-circuit) cables and more delicate than normal plastic-enclosed cables. Do not force cables out of the connectors to prevent damage.*

Disassembly Procedure Flowchart

The flowchart on the succeeding page gives you a graphic representation on the entire disassembly sequence and instructs you on the components that need to be removed during servicing. For example, if you want to remove the system board, you must first remove the keyboard, then disassemble the inside assembly frame in that order

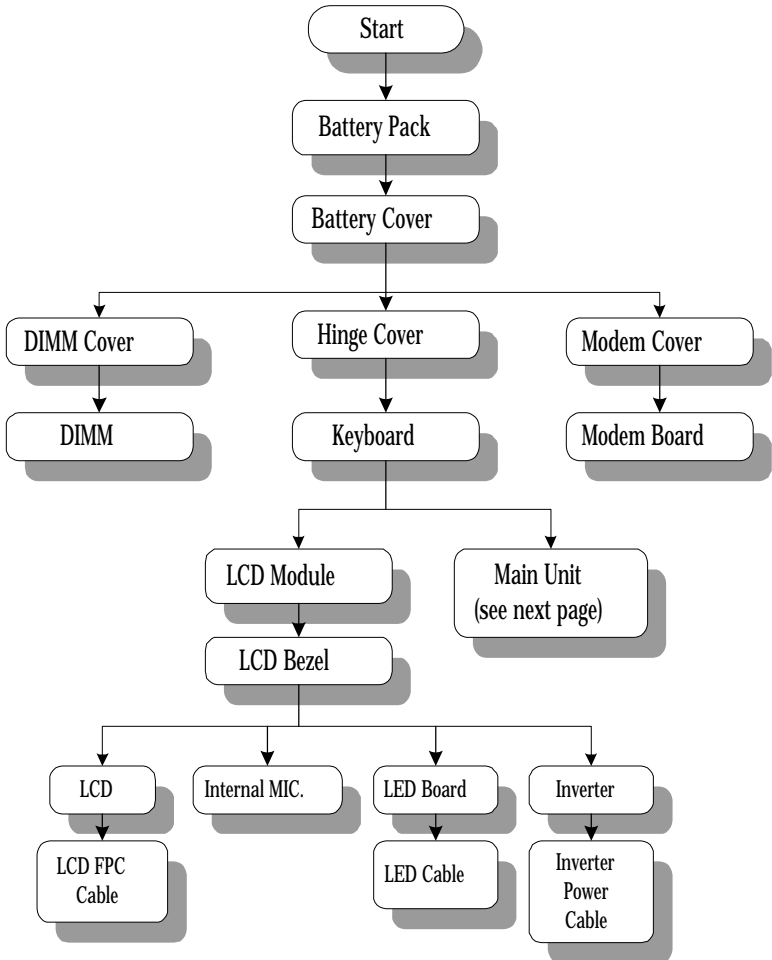

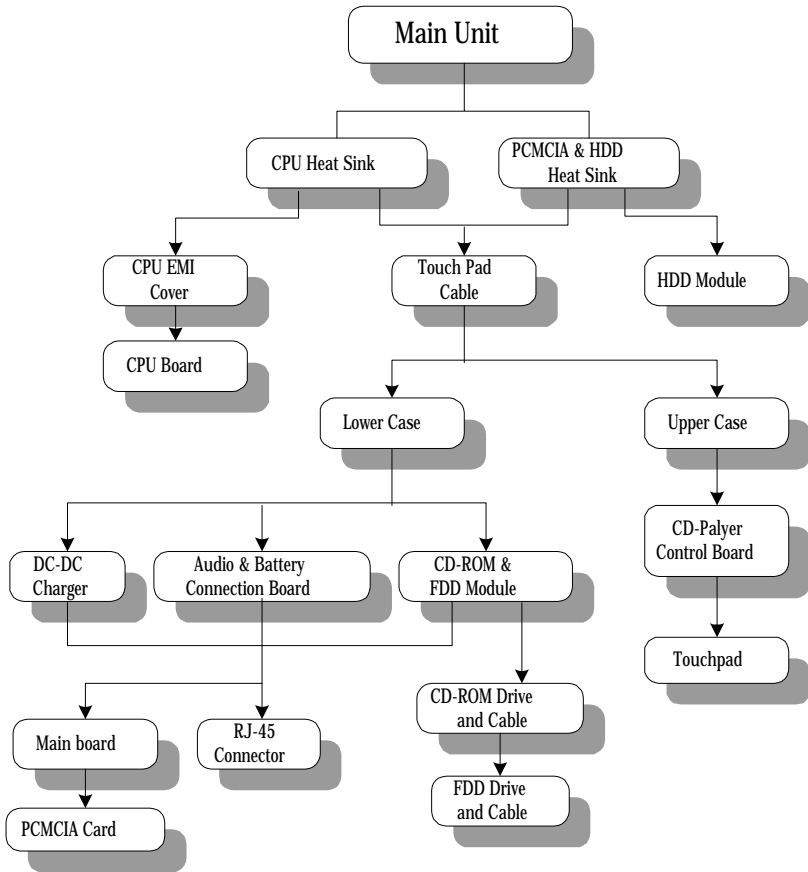

Removing the Battery Pack

1. Pull down the battery cover, slide the battery out from the main unit .I



2. To remove the battery cover, gently bend the battery cover a little bit outward, then slide the battery cover downward to remove it.



Removing the DIMM

1. Remove the two screws shown below to remove the DIMM door..



-
2. Use a plastic flat-bladed screwdriver to push the latches outward on both sides of the DIMM socket to remove the DIMM module from the DIMM socket.



Removing the Modem Board

1. Remove the screw shown below to remove the modem cover.

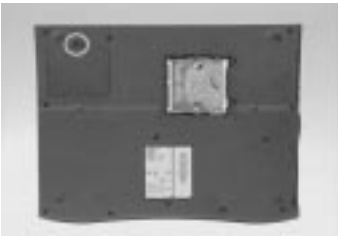

2. Use a plastic flatbladed screwdriver to push out the latches on both sides of the modem board socket to remove the modem board.



3. Disconnect the modem phone cable from the modem board.



Removing the Keyboard

1. Slide out the hinge covers on both sides of the notebook.



2. Use a plastic flatbladed screwdriver to remove the LCD FPC cover.



3. Slide the middle cover to the left side and remove the middle cover.



Note: To replace the middle cover, be sure that the latches are lined up with the uppercase as indicated.

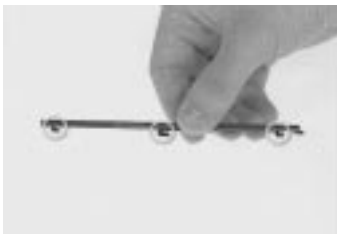

-
4. Lift the keyboard up, turn it over and carefully place on the palm rest to expose the keyboard connector.



5. Disconnect the keyboard connector CN20 as shown below.



Removing the LCD Module

1. Disconnect the internal microphone cable at CN8 from the system board.



2. Disconnect the LED cable at CN10 from the system board.

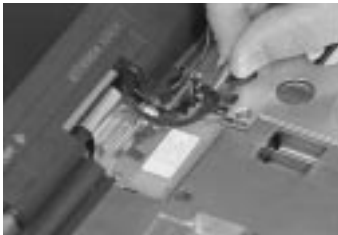

3. Remove the two screws on the LCD FPC cable.



4. Use a plastic flatbladed screwdriver to disconnect the LCD FPC cable at CN9 from the system board.

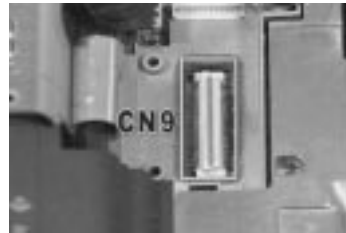

-
5. Remove the two screws from the base unit, then carefully detach the LCD module from the main unit.

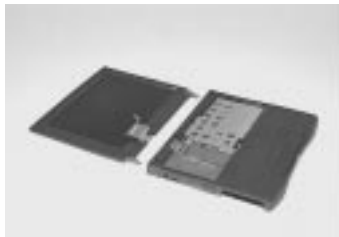

Disassembling the LCD

1. Remove the two cushions and two mylar stickers from the four corners of display bezel.



2. Remove the five screws of the LCD bezel as shown below.



3. Carefully, pull out the display bezel from the inside out.



4. Remove the two screws from the LED board, then lift the LED board from the display panel.



5. Carefully remove the internal microphone cable from the display panel.



6. Remove the six screws as shown below to separate the LCD and the LCD inverter board.

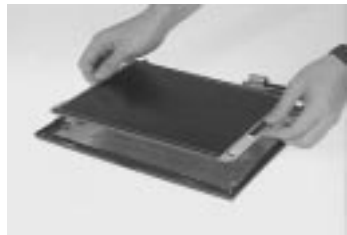

-
7. To remove the LCD inverter board, disconnect the LCD FPC cable and LCD power cable from the LCD inverter board.



8. Carefully remove the adhesive tape to remove the LCD FPC cable from the LCD.



9. This completes the disassembly of the LCD module.



Disassembling the Main Unit

Removing the HDD & PCMCIA Heat Sink

1. Remove the 2 screws from the HDD & PCMCIA heat sink.



2. Slide the HDD & PCMCIA heat sink out from the upper case, using both hands to remove.



Removing the Hard Disk Drive

1. Remove the screw from the hard disk module.



-
2. To detach the hard disk module from the main unit, gently pull up to remove. .



Removing the CPU Heat Sink and CPU Board

1. Remove the 4 screws of the CPU heat sink, then gently remove the heat sink.

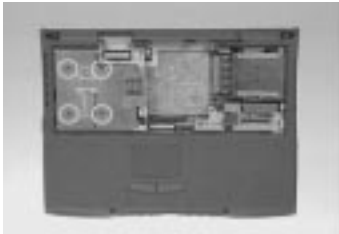

2. First remove the CPU EMI shield, to detach and remove the CPU board from the system board.



Removing the RTC Battery

1. Use a flat bladed screw driver to remove the RTC battery from its socket.



Note: *You can also remove RTC battery when the keyboard and CPU heat sink are removed.*

Note: *To re-install RTC battery, press the RTC battery into the socket*



Disassembling the Upper Case

1. Disconnect the touchpad cable from the system board at CN19.



2. Remove the 11 screws as shown below.

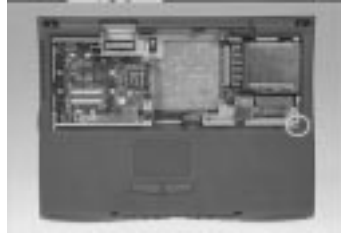
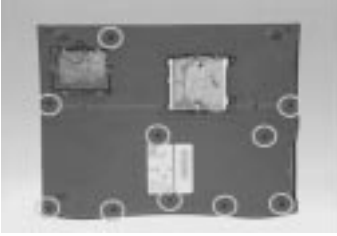

3. Lift up the upper case and disconnect the LCD cover switch from the system board at CN7 to detach the upper case from the lower case.



Removing the Touchpad

1. Disconnect the touchpad FPC cable from the touchpad board.

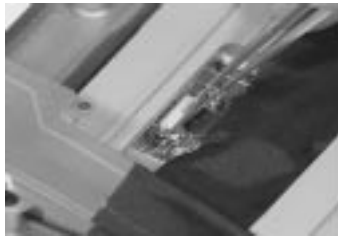

2. Remove the 6 screws of the touchpad bracket.

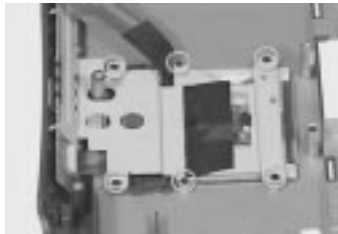

-
3. Lift the touchpad bracket, FPC cable and CD-ROM control panel board assembly away from the upper case.



4. To detach the CD-ROM control panel board, first disconnect the touchpad FPC cable, then remove the 3 screws to release it.



5. Finally, remove the touchpad board from the upper case.



Disassembling the Lower Case

1. Gently remove the speaker nets from the lower case.



Removing the CD-ROM/Diskette Drive Module

1. Disconnect the diskette drive cable and the CD-ROM drive cable at CN15 and CN16 of the system board



2. Remove this screw from the diskette and CD-ROM/diskette drive Module.



3. Gently pull up the CD-ROM/diskette drive module from the lower case.



For CD-ROM/diskette drive module, there are two types of cabling:

IMPORTANT!! Before Acer encountered problems, the cabling for the diskette drive was originally placed between the bracket of roughly 1000 pieces. In order to avoid damaging these cables, Acer then redesigned the cabling to go around the bracket instead. You may have to repair both types. In the case of the limited quantity version, you should replace the longer cable type and connect the diskette FRC cable to go around the bracket to avoid the same mistake.

Type 1 Cabling (mass-production version):

1. Remove the 3 screws located at the CD-ROM/diskette drive module's bracket to separate the CD-ROM drive from the CD-ROM/diskette drive module

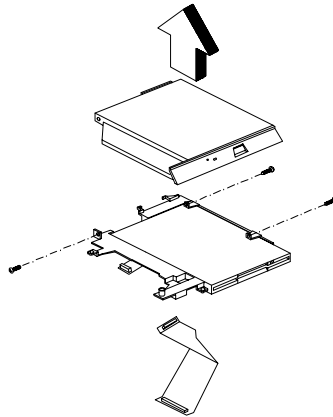

2. Remove the 3 screws from the diskette drive

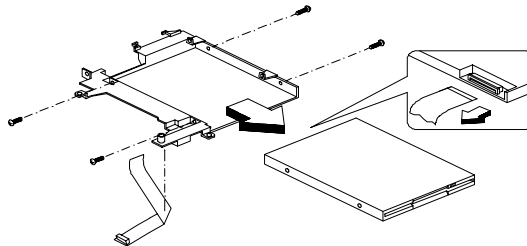

Type 2 Cabling (a limited quantity version):

-
1. Remove the 3 screws located at the CD-ROM/diskette drive module's bracket.

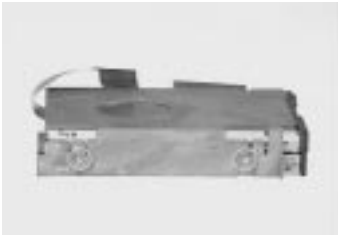

2. Separate the CD-ROM drive from the CD-ROM/diskette drive module.

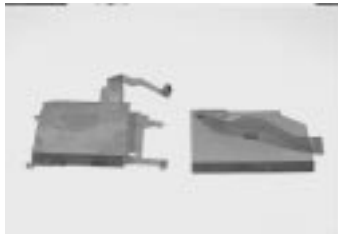

3. Remove the 3 screws from the diskette drive.



4. This completes the disassembly of the CD-ROM/diskette drive module.

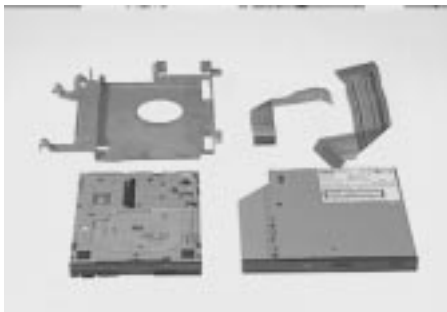

Removing the Speakers

1. Disconnect the left and right channel speaker cables from the audio-I/O and battery connection board.



2. Remove the 4 screws from the left and right speaker channels.

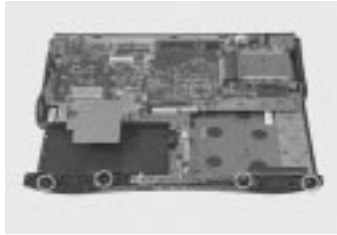

3. Remove the left and right speakers away from the lower case.



Removing the DC-DC/Charger Board

1. Disconnect the charger board from CN23.

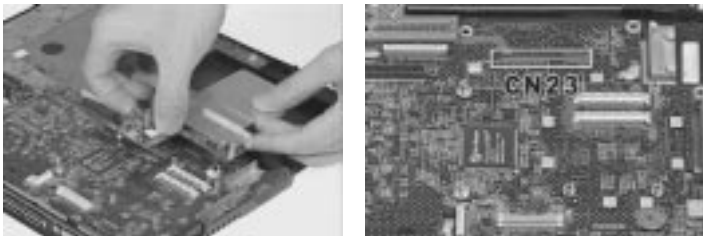

2. Remove the 2 screws from the audio-I/O and battery connection board



Removing the DC-DC/Charger Board

1. Gently pull upward to remove the audio-I/O and battery connection board from the system board.

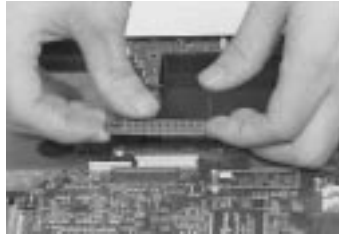

Removing the System Board

1. Disconnect these 2 screws from the system board.

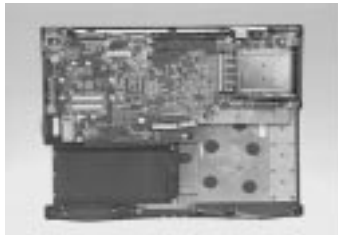

-
2. Remove the modem phone jack shield from the system board.



9. Remove the system board from the lower case.



Removing the PCMCIA slot

1. Remove the 4 screws around the PCMCIA slot.

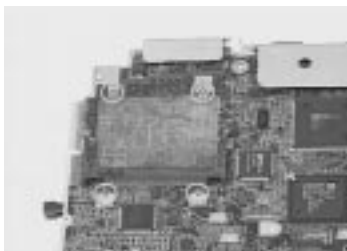

2. Turn the board over, gently lift up the PCMCIA slot.



Removing the Modem Phone Jack

1. Remove the modem phone jack from the lower case.



2. This completes the disassembly of the lower case.

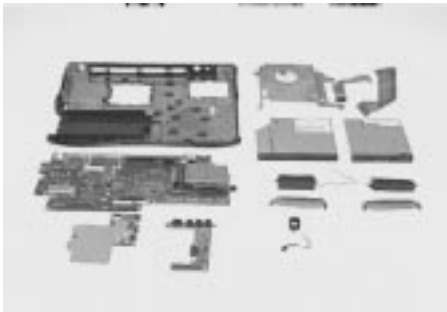

Troubleshooting

Use the following procedure as a guide for computer problems.

Note: *The diagnostic tests are intended to test only Acer products. Non-Acer products, prototype cards, or modified options can give false errors and invalid system responses.*

1. Obtain the failing symptoms in as much detail as possible.
2. Verify the symptoms by attempting to re-create the failure by running the diagnostic test or by repeating the same operation.
3. Use the following table with the verified symptom to determine which page to go to.

Symptoms (Verified)	Go To
Power failure. (The power indicator does not go on or stay on.)	"Power System Check" on page 75.
POST does not complete. No beep or error codes are indicated.	"Error Symptom-to-FRU Index" on page 78. "Undetermined Problems" on page 86
POST detects an error and displayed messages on screen.	"Error Messages List" on page 78
The diagnostic test detected an error and displayed a FRU code.	See "Running PQA Diagnostics Program." on page 45
Other symptoms (i.e. LCD display problems or others).	"Error Symptom-to-FRU Index" on page 78
Symptoms cannot be re-created (intermittent problems).	Use the customer-reported symptoms and go to "Error Symptom-to-FRU Index" on page 78 "Intermittent Problems" on page 86 "Undetermined Problems" on page 86

System Check Procedures

Diskette Drive Check

Do the following to isolate the problem to a controller, driver, or diskette. A write-enabled, diagnostic diskette is required.

Note: *Make sure that the diskette does not have more than one label attached to it. Multiple labels can cause damage to the drive or cause the drive to fail.*

Do the following to select the test device. See “Running the Diagnostics” for details.

1. Boot from the diagnostics diskette and start the PQA program (See “Running PQA Diagnostics Program.” on page 45).
2. Go to the diagnostic Diskette Drive in the test items.
3. Press F2 in the test items.
4. Follow the instructions in the message window.

If an error occurs with the internal diskette drive, reconnect the diskette connector on the system board.

If the error still remains:

1. Reconnect the diskette drive.
2. Replace the diskette driver cable.
3. Replace the diskette.
4. Replace the system board.

CD-ROM Drive Check

Do the following to isolate the problem to a controller, drive, or CD-ROM. Make sure that the CD-ROM does not have any label attached to it. The label can cause damage to the drive or can cause the drive to fail.

Do the following to select the test device:

1. Boot from the diagnostics diskette and start the PQA program (refer to “Running PQA Diagnostics Program”).
2. Go to the diagnostic CD-ROM in the test items.
3. Press F2 in the test items.
4. Follow the instructions in the message window.

If an error occurs, reconnect the connector on the System board. If the error still remains:

1. Reconnect CD-ROM drive.

-
2. Replace the CD-ROM drive.
 3. Replace the system board.

Keyboard or Auxiliary Input Device Check

Remove the external keyboard if the internal keyboard is to be tested.

If the internal keyboard does not work or an unexpected character appears, make sure that the flexible cable extending from the keyboard is correctly seated in the connector on the system board.

If the keyboard cable connection is correct, run the Keyboard Test. See “Running the Diagnostics” for details.

If the tests detect a keyboard problem, do the following one at a time to correct the problem. Do not replace a non-defective FRU:

1. Reconnect the keyboard cables.
2. Replace the keyboard.
3. Replace the system board.

The following auxiliary input devices are supported by this computer:

- Numeric keypad
- External keyboard

If any of these devices do not work, reconnect the cable connector and repeat the failing operation.

Memory Check

Memory errors might stop system operations, show error messages on the screen, or hang the system.

1. Boot from the diagnostics diskette and start the PQA program (please refer to “Running PQA Diagnostics Program”).
2. Go to the diagnostic memory in the test items.
3. Press F2 in the test items.
4. Follow the instructions in the message window.

Note: *Make sure that the DIMM is fully installed into the connector. A loose connection can cause an error.*

Power System Check

To verify the symptom of the problem, power on the computer using each of the following power sources:

1. Remove the battery pack.

-
2. Connect the power adapter and check that power is supplied.
 3. Disconnect the power adapter and install the charged battery pack; then check that power is supplied by the battery pack.

If you suspect a power problem, see the appropriate power supply check in the following list:

- “Check the Power Adapter” on page 76
- “Check the Battery Pack” on page 76

Check the Power Adapter

Unplug the power adapter cable from the computer and measure the output voltage at the plug of the power adapter cable. See the following figure

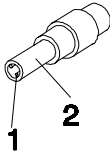

Pin 1: +19 to +20.5V
Pin 2: 0V, Ground

1. If the voltage is not correct, replace the power adapter.
2. If the voltage is within the range, do the following:
 - Replace the System board.
 - If the problem is not corrected, see “Undetermined Problems” on page 86.
 - If the voltage is not correct, go to the next step.

Note: *An audible noise from the power adapter does not always indicate a defect.*
3. If the power problem occurs only when the port replicator is used, replace the port replicator.
4. If the power-on indicator does not light up, check the power cord of the power adapter for correct continuity and installation.
5. If the operational charge does not work, see “Check the Battery Pack” on page 76.

Check the Battery Pack

To check the battery pack, do the following:

1. Power off the computer.

-
2. Remove the battery pack and measure the voltage between battery terminals 2(+) and 7(ground). See the following figure

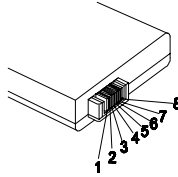

3. If the voltage is still less than 8.0 Vdc after recharging, replace the battery.

To check the battery charge operation, use a discharged battery pack or a battery pack that has less than 50% of the total power remaining when installed in the computer.

If the battery status indicator does not light up, remove the battery pack and let it return to room temperature. Reinstall the battery pack.

If the charge indicator still does not light up, replace the battery pack. If the charge indicator still does not light up, replace the DC/DC charger board.

Touchpad Check

If the touchpad doesn't work, do the following actions one at a time to correct the problem. Do not replace a non-defective FRU:

1. Reconnect the touchpad cables.
2. Replace the touchpad.
3. Replace the touchpad.

After you use the touchpad, the pointer drifts on the screen for a short time. This self-acting pointer movement can occur when a slight, steady pressure is applied to the touchpad pointer. This symptom is not a hardware problem. No service actions are necessary if the pointer movement stops in a short period of time.

Error Symptom-to-FRU Index

The symptom-to-FRU index lists the symptoms and errors and their possible causes. The most likely cause is listed first.

Note: *Perform the FRU replacement or actions in the sequence shown in FRU/Action column, if the FRU replacement does not solve the problem, put the original part back in the computer. Do not replace a non-defective FRU.*

This index can also help you determine the next possible FRU to be replaced when servicing a computer.

If the symptom is not listed, see “Undetermined Problems” on page 86.

The following lists the error messages that the BIOS displays on the screen and the error symptoms classified by function.

Note: *Most of the error messages occur during POST. Some of them display information about a hardware device, e.g., the amount of memory installed. Others may indicate a problem with a device, such as the way it has been configured.*

Note: *If the system fails after you make changes in the BIOS Setup Utility menus, reset the computer, enter Setup and install Setup defaults or correct the error*

Error Messages List

Error Messages	Action in Sequence
Failure Fixed Disk	Reconnect hard disk drive connector. “Load Default Settings” in BIOS Setup Utility. Hard disk drive System board
Stuck Key	See “Keyboard or Auxiliary Input Device Check” on page 75.
Keyboard error	See “Keyboard or Auxiliary Input Device Check” on page 75.
Keyboard Controller Failed	See “Keyboard or Auxiliary Input Device Check” on page 75.
Keyboard locked - Unlock key switch	Unlock external keyboard
Monitor type does not match CMOS - Run Setup	Run “Load Default Settings” in BIOS Setup Utility.
Shadow RAM Failed at offset: nnnn	BIOS ROM System board
System RAM Failed at offset: nnnn	DIMM System board

Error Messages List

Error Messages	Action in Sequence
Extended RAM Failed at offset:nnnn	DIMM System board
System battery is dead - Replace and run Setup	Replace RTC battery and Run BIOS Setup Utility to reconfigure system time, then reboot system.
System CMOS checksum bad - Default configuration used	RTC battery Run BIOS Setup Utility to reconfigure system time, then reboot system.
System timer error	RTC battery Run BIOS Setup Utility to reconfigure system time, then reboot system. System board
Real time clock error	RTC battery Run BIOS Setup Utility to reconfigure system time, then reboot system. System board
Previous boot incomplete - Default configuration used	Run "Load Default Settings" in BIOS Setup Utility. RTC battery System board
Memory size found by POST differed from CMOS	Run "Load Default Settings" in BIOS Setup Utility. DIMM System board
Diskette drive A error	Check the drive is defined with the proper diskette type in BIOS Setup Utility See "Diskette Drive Check" on page 74.
Incorrect Drive A type - run SETUP	Check the drive is defined with the proper diskette type in BIOS Setup Utility See "Diskette Drive Check" on page 74.
System cache error - Cache disabled	CPU board System board
CPU ID:	CPU board System board
DMA Test Failed	DIMM CPU board System board
Software NMI Failed	DIMM CPU board System board

Error Messages List

Error Messages	Action in Sequence
Fail-Safe Timer NMI Failed	DIMM CPU board System board
Device Address Conflict	Run "Load Default Settings" in BIOS Setup Utility. RTC battery System board
Allocation Error for: device	Run "Load Default Settings" in BIOS Setup Utility. RTC battery System board
Failing Bits: nnnn	DIMM BIOS ROM System board
Fixed Disk n	None
Invalid System Configuration Data	BIOS ROM System board
I/O device IRQ conflict	Run "Load Default Settings" in BIOS Setup Utility. RTC battery System board
Operating system not found	Enter Setup and see if fixed disk and drive A: are properly identified. Diskette drive Hard disk drive System board

No-Beep Symptoms

Symptom / Error	Action in Sequence
No beep, power-on indicator turns off and LCD is blank.	Power source (battery pack and power adapter). See "Power System Check" on page 75. Ensure every connector is connected tightly and correctly. Reconnect the DIMM. CPU board. DC-DC/charger board. System board

No-Beep Symptoms

Symptom / Error	Action in Sequence
No beep, power-on indicator turns on and LCD is blank.	Power source (battery pack and power adapter). See "Power System Check" on page 75. Reconnect the LCD connector DC-DC/charger board CPU board. Hard disk drive LCD inverter ID LCD FPC cable Inverter LCD System board
No beep, power-on indicator turns on and LCD is blank. But you can see POST on an external CRT.	Reconnect the LCD connectors. LCD inverter ID LCD FPC cable LCD inverter LCD System board
No beep, power-on indicator turns on and a blinking cursor shown on LCD during POST.	Ensure every connector is connected tightly and correctly. System board
No beep during POST but system runs correctly.	Speaker System board

LCD-Related Symptoms

Symptom / Error	Action in Sequence
LCD backlight doesn't work LCD is too dark LCD brightness cannot be adjusted LCD contrast cannot be adjusted	Enter BIOS Utility to execute "Load Setup Default Settings", then reboot system. Reconnect the LCD connectors. Keyboard (if contrast and brightness function key doesn't work). LCD inverter ID LCD FPC cable LCD inverter LCD System board

LCD-Related Symptoms

Symptom / Error	Action in Sequence
Unreadable LCD screen Missing pels in characters Abnormal screen Wrong color displayed	Reconnect the LCD connector LCD inverter ID LCD FPC Cable LCD inverter LCD System board
LCD has extra horizontal or vertical lines displayed.	LCD inverter ID LCD inverter LCD FPC Cable LCD System board

Indicator-Related Symptoms

Symptom / Error	Action in Sequence
Indicator incorrectly remains off or on, but system runs correctly	Reconnect the LED board LED board System board

Power-Related Symptoms

Symptom / Error	Action in Sequence
Power shuts down during operation	Power source (battery pack and power adapter). See "Power System Check" on page 75. Battery pack Power adapter DC-DC/charger board Audio-I/O & battery connection board System board
The system doesn't power-on.	Power source (battery pack and power adapter). See "Power System Check" on page 75. Battery pack Power adapter DC/DC & Charge boar Audio-I/O & battery connection board System board

Power-Related Symptoms

Symptom / Error	Action in Sequence
The system doesn't power-off.	Power source (battery pack and power adapter). See "Power System Check" on page 75. Hold and press the power switch for more than 4 seconds. Charger board System board
Battery can't be charged	See "Check the Battery Pack" on page 76. Battery pack DC-DC/charger board System board

PCMCIA-Related Symptoms

Symptom / Error	Action in Sequence
System cannot detect the PC Card (PCMCIA)	PCMCIA slot assembly System board
PCMCIA slot pin is damaged.	PCMCIA slot assembly

Memory-Related Symptoms

Symptom / Error	Action in Sequence
Memory count (size) appears different from actual size.	Enter BIOS Setup Utility to execute "Load Default Settings, then reboot system. DIMM System board

Speaker-Related Symptoms

Symptom / Error	Action in Sequence
In DOS or Windows, multimedia programs, no sound comes from the computer.	Press Fn-F8, Speaker ON/OFF control. Audio driver Speaker System board
Internal speakers make noise or emit no sound.	Press Fn-F8, Speaker ON/OFF control. Speaker System board

Power Management-Related Symptoms

Symptom / Error	Action in Sequence
The system will not enter hibernation	Keyboard (if control is from the keyboard) Hard disk drive System board
The system doesn't enter hibernation mode and four short beeps every minute.	See "Hibernation Mode" on page 31. Ensure the "Heuristic Power Management Mode" in the Power Management of BIOS Setup Utility is not set to [OFF]. Press Fn+F4 and see if the computer enters hibernation mode. Touchpad Keyboard Hard disk connection board Hard disk drive System board
The system doesn't enter standby mode after closing the LCD	See "System Standby Mode" on page 30. LCD cover switch System board
The system doesn't resume from hibernation mode.	See "Hibernation Mode" on page 31. Hard disk connection board Hard disk drive System board
The system doesn't resume from standby mode after opening the LCD.	See "System Standby Mode" on page 23. LCD cover switch System board
Battery fuel gauge in Windows doesn't go higher than 90%.	Remove battery pack and let it cool for 2 hours. Refresh battery (continue use battery until power off, then charge battery). Battery pack Charger board System board
System hangs intermittently.	See "Set Thermal Sensor Threshold" on page 43. Reconnect hard disk/CD-ROM drives. Hard disk connection board System board

Peripheral-Related Symptoms

Symptom / Error	Action in Sequence
System configuration does not match the installed devices.	Enter BIOS Setup Utility to execute "Load Default Settings", then reboot system. Reconnect hard disk/CD-ROM/diskette drives.
External display does not work correctly.	Press Fn+F5, LCD/CRT/Both display switching See "Running PQA Diagnostics Program." on page 45. System board
USB does not work correctly	See "System Diagnostic Diskette" on page 44 System board
Print problems.	Ensure the "Parallel Port" in the "Onboard Devices Configuration" of BIOS Setup Utility is set to Enabled. Onboard Devices Configuration Run printer self-test. Printer driver Printer cable Printer System Board
Serial or parallel port device problems.	Ensure the "Serial Port" in the Devices Configuration" of BIOS Setup Utility is set to Enabled. Device driver Device cable Device System board

Keyboard/Touchpad-Related Symptoms

Symptom / Error	Action in Sequence
Keyboard (one or more keys) does not work.	Reconnect the keyboard cable. Keyboard System board
Touchpad does not work.	Reconnect touchpad cable. Touchpad board System board

Modem-Related Symptoms

Symptom / Error	Action in Sequence
Internal modem does not work correctly.	See "System Diagnostic Diskette" on page 44. Modem phone jack Modem board System board

Note: *If you cannot find a symptom or an error in this list and the problem remains, see "Undetermined Problems".*

Intermittent Problems

Intermittent system hang problems can be caused by a variety of reasons that have nothing to do with a hardware defect, such as: cosmic radiation, electrostatic discharge, or software errors. FRU replacement should be considered only when a recurring problem exists.

When analyzing an intermittent problem, do the following:

1. Run the advanced diagnostic test for the system board in loop mode at least 10 times.
2. If no error is detected, do not replace any FRU.
3. If any error is detected, replace the FRU. Rerun the test to verify that there are no more errors.

Undetermined Problems

The diagnostic problems does not identify which adapter or device failed, which installed devices are incorrect, whether a short circuit is suspected, or whether the system is inoperative.

Follow these procedures to isolate the failing FRU (do not isolate non-defective FRU).

Note: *Verify that all attached devices are supported by the computer.*

Note: *Verify that the power supply being used at the time of the failure is operating correctly. (See "Power System Check" on page 75):*

1. Power-off the computer.
2. Visually check them for damage. If any problems are found, replace the FRU.
3. Remove or disconnect all of the following devices:
 - ❑ Non-Acer devices
 - ❑ Devices attached to the port replicator

-
- Printer, mouse, and other external devices
 - Battery pack
 - Hard disk drive
 - DIMM
 - CD-ROM
 - Diskette drive
 - PC Cards
4. Power-on the computer.
 5. Determine if the problem has changed.
 6. If the problem does not recur, reconnect the removed devices one at a time until you find the failing FRU.
 7. If the problem remains, replace the following FRU one at a time. Do not replace a non-defective FRU:
 - System board
 - LCD assembly
 - CPU card

Connectors and Jumpers

Top View

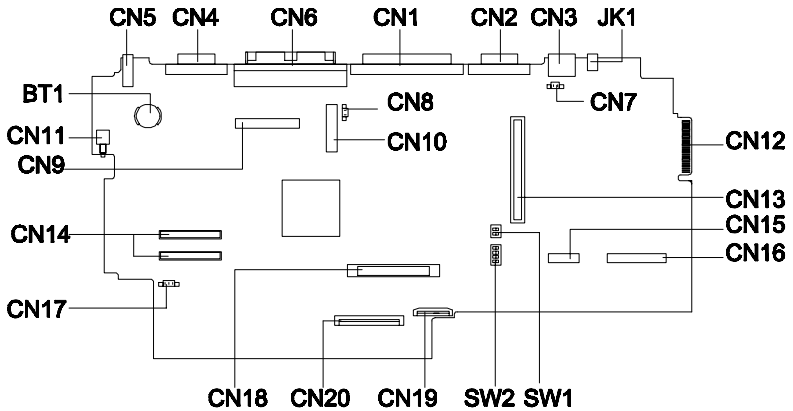

CN11	Power Switch	CN16	CD-ROM Connector
CN9	LCD Connector	CN15	FDD Connector
CN14	CPU Connectors	CN13	PCMCIA Socket
CN17	Fan Connector (reserved)	CN12	Golden Finger for Debug Board
CN18	HDD Connector	CN7	LCD Cover Switch Connector
CN20	Keyboard Connector	CN8	Internal Microphone Connector
CN19	Touchpad Connector	CN10	LED Board Connector
SW1	See Next Page	JK1	AC Adapter Connector
SW2	See Next Page	CN3	PS/2 Port
CN2	Serial Port	CN1	Parallel Port
CN6	Port Replicator	CN4	Video Port
CN5	USB Port	BT1	RTC Battery

SW1 Settings

SW1	Setting
Switch 1, Switch 2	Default at OFF setting, un-configurable.

SW2 Settings

SW2	Setting
Switch 1	ON: OEM BIOS OFF: Acer BIOS
Switch 2	ON: Bypass password OFF: Check password
Switch 3, Switch 4	OFF, OFF: US keyboard OFF, ON: European keyboard ON, OFF: Japanese keyboard



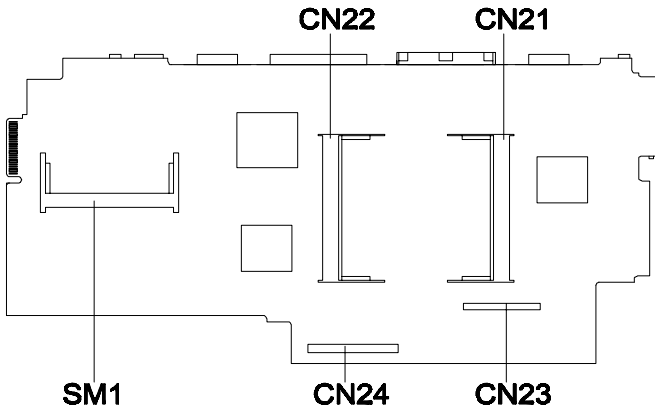





Bottom View













- SM1 Modem Socket
- CN23, CN24 Charger Connector
- CN21 DIMM Socket 2
- CN22 DIMM Socket 1

Spare Parts List

Spare Parts List (P/N:91.45BXX.XXX)

Part Name	Description	Part No.*	Q'ty†	
12.1" DSTN LCD				
	LCD Module 12.1" DSTN	ASSY 12.1"DSTN LCD MODULE	6M.45B09.001	1
	LCD DSTN 12.1" DSTN	LCD 12.1DSTN LM121SS1T53 BLACK	56.0743B.001	1
	Inverter	INVERTER T62.086.C 700	19.21030.181	5
	LED cable	W.A 10/10P 120MM LED AN500	50.45B11.001	5
	LED board	EXTENSA 700 LED BOARD	55.47A03.001	5
	LCD FPC 12.1" DSTN	ASSY LCD FPC 12.1 DSTN 700	60.47A07.071	1
	LCD panel 12.1" DSTN	ASSY LCD PNL (HIT12.1"DSTN)70 0	60.45B02.031	1
	LCD bezel	ASSY LCD BZL (12.1") 700	60.47A09.021	5





Spare Parts List (P/N:91.45BXX.XXX)

Part Name		Description	Part No.*	Qty†
	Hinge pair pack	ASSY HINGE PACK TM500	6M.45B07.001	5
12.1" TFT LCD				
	LCD Module 12.1" TFT	ASSY 12.1"TFT LCD MODULE TM500	6M.45B09.011	1
	LCD TFT	LCD TFT 12.1 TX31D27VC1CAB	56.0746B.011	1
	Inverter	INVERTER T62.086.C 700	19.21030.181	5
	LED cable	W.A 10/10P 120MM LED AN500	50.45B11.001	5
	LED board	EXTENSA 700 LED BOARD	55.47A03.001	5
	LCD FPC TFT	ASSY LCD FPC (HIT 12.1 TFT)	60.45B11.011	1
	LCD panel TFT	ASSY LCD PNL(IBM 12.1")700	60.47A08.023	1
	LCD bezel	ASSY LCD BZL (12.1") 700	60.47A09.021	5
	Hinge Package	ASSY HINGE PACK TM500	6M.45B07.001	5

Spare Parts List (P/N:91.45BXX.XXX)

Part Name	Description	Part No.*	Q'ty†	
PC board				
	System board	500 MAIN BOARD	55.45B01.001	1
	DC-DC/ charger board	DC/DC CHARG T62.101.C.00 V.P2	19.21030.391	1
	Modem board (CIS)	MODEM MODULE AC-5614BMCB	54.09041.051	1
	Modem board (Ambit)	MODEM 1641B AMBIT/ T62.103.C.00	54.09042.001	1
	Audio I/O and battery connection board	500 AUDIO BOARD 4L	55.45B04.001	5
	CD-ROM control panel board	500 CD-ROM CONTROL BOARD	55.45B05.001	5
CPU				
	CPU-233 ACER	500 CPU BOARD T-233	55.45B02.041	1
	CPU-233 Hitachi	VEGA CPU BOARD T-233	55.45B02.021	1
	CPU-266 ACER	500 CPU BOARD T-266	55.45B02.031	1
	CPU EMI shield	ASSY CPU EMI BRKT AN500	60.45B13.001	50
	CPU heat sink	ASSY CPU HSINK AN500	60.45B10.001	5
HDD				

Spare Parts List (P/N:91.45BXX.XXX)

Part Name		Description	Part No.*	Q'ty†
	HDD module	IBM/DTCA23240 HDD MODULE TM500	6M.45B05.001	1
	HDD module	HIT/DK226K32U HDD MODULE TM500	6M.45B05.011	1
	HDD module	IBM/DKLA23240 HDD MODULE TM500	6M.45B05.021	1
	HDD module	IBM/DKLA24320 HDD MODULE TM500	6M.45B05.031	1
	HDD	HDD 3240MB 2.5"IBM/ DTCA23240	56.02995.001	1
	HDD	HDD 3240MB HIT/ DK226K-32U IDE	56.02973.011	1
	HDD	HDD 3.2G IBM/ DKLA23240	56.02971.021	1
	HDD	HDD 4.3G IBM/ DKLA24320	56.02834.101	1
	HDD connection board	500 HDD TRANSPORT BOARD 2L	55.45B03.001	5
	HDD bracket pack	ASSY HDD BRACKET PACK TM500	6M.45B06.001	5
Touchpad				
	Touchpad	TOUCHPAD SYNAPTICS/TM4- 220	56.1748A.001	5
	Touchpad bracket	ASSY T-P BRK AN500	60.45B09.002	5
	Touchpad and CD-ROM control panel board module	TOUCHPAD/ CDROM CONTROL BD TM500	6M.45B15.001	5









Spare Parts List (P/N:91.45BXX.XXX)

Part Name		Description	Part No.*	Qty†
	Touchpad FPC	C.A FPC TOUCH PAD AN500	50.45B05.001	5
CD-ROM & FDD				
	CD-ROM & FDD module	ASSY CD-ROM & FDD MODULE TM500	6M.45B02.001	1
	CD-ROM	CD DRV TEAC/ CD-220EA-25 20X	56.10061.091	1
	CD-ROM	CD DRV 20X TEAC/CD-220EA-EB	56.10061.111	1
	FDD	FDD W/500 BZL MITS/D353F3X	56.01051.371	1
	FDD Cable	C.A FPC FDD AN500	50.45B07.001	5
	CD-ROM Cable	C.A FPC CD-ROM AN500	50.45B06.001	5
	CD-ROM & FDD bracket	ASSY BRKT CD-FDD AN500	60.45B14.002	5
DIMM				





Spare Parts List (P/N:91.45BXX.XXX)

Part Name		Description	Part No.*	Q'ty†
	DIMM 16MB NEC	SDRAM MDL 253309-A10 16MB 3.3V	72.25330.00N	1
	DIMM 16MB Mitsubishi	SO-DIMM M5M4V16S3013T P-10 16MB	72.54163.00N	1
	DIMM 32MB NEC	SO-DIMM 253409- 10 32MB(NEC)	72.25349.00N	1
	DIMM 32MB Mitsubishi	S0-DIMM M5M4V64S40ATP- 10L 32MB	72.54644.00N	1
	DIMM 64MB NEC	S0-DIMM 253509- 10(64MB)NEC	72.25359.00N	1
	DIMM 64MB	SODIMM M5M4V64S40ATP- 10L 64MB	72.54644.A0N	1
Mechanical parts				
	Battery door	DOOR BATTERY PC AN500	42.45B04.001	50
	Modem and DIMM door pack	ASSY COVER PACK TM500	6M.45B03.001	5
	Speaker net pack	ASSY SPEAKER NET PACK TM500	6M.45B14.001	5
	HDD and PCMCIA heat sink	ASSY UP HSINK PC+AL AN500	60.45B05.002	50
	CPU EMI shield	ASSY CPU EMI BRKT AN500	60.45B13.002	50
	CPU heat sink	ASSY CPU HSINK AN500	60.45B10.001	5



Spare Parts List (P/N:91.45BXX.XXX)

Part Name		Description	Part No.*	Q'ty†
	Hinge pair pack	ASSY HINGE PACK TM500	6M.45B07.001	5
	Hinge cover pair pack	ASSY HINGE COVER PACK TM500	6M.45B08.001	50
	Middle cover (long)	CVR MIDDLE (1) PC 050 AN500	42.45B01.001	50
	Middle cover (short)	CVR MIDDLE (2)PC 050 AN500	42.45B02.001	50
	Modem phone jack shield	BKT RJII SECC AN500	33.45B09.001	50
	Lower case	ASSY L CASE AN500	60.45B06.002	5
	Upper case	ASSY U CASE 500	60.45B03.002	5
Keyboard				
	Keyboard (English)	NSK-84A01	91.78S07.001	1
	Keyboard (German)	NSK-85A0G	91.78S07.00G	1
	Keyboard (Traditional Chinese)	NSK-84A0C	91.78S07.00C	1

Spare Parts List (P/N:91.45BXX.XXX)

Part Name		Description	Part No.*	Q'ty†
Battery				
	Battery pack	ASSY BTY PACK BTP-1731 VEGA	60.45B04.001	1
	Battery pack	ASSY BTY PACK BTP-1831 500	60.45B04.011	1
	Battery RTC	BTY LI 3V CR1220 36MAH	23.20004.091	50
AC adapter				
	Adapter	ADT 90-270V ADP-45GB V.E5 370P	25.10046.151	1
	Adapter	ADT 120VAC/ 9VDC 1A WP480909DG	25.10048.001	1
Power cord				
	Power cord (U.S.)	CORD SPT-2 #18*2C 7A125V1830MM	27.01618.001	50
	Power cord (Japan)	CORD T-MARK 2P 7A 125V JAPAN	27.03518.001	5
	Power cord (South America)	CORD H03VVH2- F 2G 2.5A250V S.A	27.01418.021	5
	Power cord (U.K.)	CORD H03VVH2- F 2G 2.5A250V UK	27.01218.031	5
	Power cord (Europe)	CORD H03VVH2- F #18*2C 2.5A250V	27.01218.021	50
	Power cord (Australia)	CORD SAA 2C 7.5A 250V(AUS)2LDF	27.01318.021	50
Miscellaneous parts				
	Speaker pair pack	ASSY SPEAKER PACK TM500	6M.45B13.001	1

Spare Parts List (P/N:91.45BXX.XXX)

Part Name		Description	Part No.*	Q'ty†
	Modem phone jack	W.A. JACK6P/3P 80MM AN500	50.45B04.001	
	CD-player button knob	KNOB CD POWER PC 050 AN500	42.45B05.002	50
	Microphone	ASSY MICROPHONE & RUBBER PACK TM500	6M.45B10.001	50
	Cushion & foot pack	ASSY CUSHION & FOOT	6M.45B04.001	50
	Name plate & hinge mylar pack	ASSY NAMEPLATE/ HINGE MYLAR PACK TM500	6M.45B11.001	5
	CD-ROM & FDD module mylar pack	ASSY CDROM FDD MODULE MYLAR TM500	6M.45B02.011	50
	Screw pack	ASSY SCREW PACK TM500	6M.45B12.001	5

* Part numbers are subject to change without notice. Contact the Acer Spare Parts department or access the spare parts database at <http://csd.acer.com.tw> for updates.

† Minimum ordering quantity

Model Definitions

Model Number Definitions

Model Number	LCD	CPU	Memory	HDD	Battery / Modem
500DX	12.1" STN	Mobil Pentium Processor - 233 MHz	32MB	3.2GB	NiMH / Fax Modem
501DX	12.1" STN	Mobil Pentium Processor - 266 MHz	32MB	3.2GB	NiMH / Fax Modem
500T	12.1" TFT	Mobil Pentium Processor - 233 MHz	32MB	3.2GB	NiMH / Fax Modem
501T	12.1" TFT	Mobil Pentium Processor - 266 MHz	32MB	3.2GB	NiMH / Fax Modem



Compatibility Tested Components

This computer's compatibility is tested and verified by Acer's internal testing department. All of its system functions are tested under Windows 95 (4.00.950C), Windows 98 and Windows NT 4.0 environments. In addition to these tests, the network communication functions are also tested under Novell Netware 3.12 and Novell Netware 4.11 environments and the Year 2000 support capability has been verified too.

Refer to the following lists for components, adapter cards, and peripherals which have passed these tests. Regarding configuration, combination and test procedures, please refer to the Extensa 500 Compatibility Test Report released by the Acer Mobile System Testing Department.

- Test Compatible PCMCIA ATA Drive
 - VIPER 170E (170MB)
 - Seagate SunDisk ST72P5 (2.5MB)
 - Seagate SunDisk ST75P5 (5MB)
 - Seagate SunDisk ST710P5 (10MB)
 - Seagate SunDisk ST720P5 (20MB)
 - SFM020W Flash Memory (20MB)
 - Viking ATA Flash Card FL4M5VA (4MB)
 - Viking ATA Flash Card FL8M5VA (8MB)
 - Viking ATA Flash Card FL16M5VA (16MB)
- Test Compatible PCMCIA SCSI Card
 - Adaptec APA-460 Slim SCSI
 - Adaptec APA-1480 SCSI
 - IBM Fast-SCSI
- Test Compatible PCMCIA CD-ROM
 - Panasonic KXL-810A (x20, PCMCIA)
 - Panasonic KXL-D740 (x4, SCSI)
- Test Compatible PCMCIA ZV Card
 - Margi Margi
 - Fuji FujiFilm
- Test Compatible PCMCIA Ethernet LAN Adapter
 - 3Com Etherlink III PCMCIA (3C589C)
 - 3Com Etherlink III PCMCIA (3C589D)
 - 3Com (3C562C/3C563C) EtherLink III + 336 Modem PC Card
 - D-Link DE-650CT PCMCIA Adapter
 - D-Link DE-660 PCMCIA Adapter

-
- ❑ IBM Ethernet Credit Card Adapter II
 - ❑ IBM EtherJet PC Card
 - ❑ IBM Ethernet Card II
 - ❑ SMC Elite Card PCMCIA (SMC 8016)
 - ❑ TDK LAN LAC-CD021
 - ❑ TI Ethernet PCMCIA Adapter II
 - ❑ TDKLan LAK-CD021
 - ❑ Test Compatible PCMCIA CardBus Card
 - ❑ 3Com Fast Etherlink XL (3C575-TX)
 - ❑ TOSHIBA CardBus 100BASE-TX
 - ❑ Xircom CardBus Ethernet 10/100
 - ❑ Intel EtherExpress PRO/100 Mobile Adapter 32Bit (Card Bus)
 - ❑ Ethernet+Modem COMBO Card
 - ❑ Eiger Labs 28.8 LAN/Modem Combo Card
 - ❑ Megahertz CC-XJEM3288 Multifunction Card
 - ❑ Motorola PCMCIA 28.8 Modem/Fax/LAN Adapter
 - ❑ Olicom OC-2220 Ethernet GoCard
 - ❑ Olicom OC-2232 GoCard Ethernet/Modem 336
 - ❑ XircomCE-0/ACorporateSeries Ccredit Card Ethernet Adapter
 - ❑ Xircom Credit Card Ethernet Adapter IIPS
 - ❑ Xircom Credit CardEthernet 10/100 (CE3-10/100)
 - ❑ Xicom Credit Card Ethernet + Modem 28.8
 - ❑ Xicom Credit Card Ethernet + Modem 33.6
 - ❑ Test Compatible PCMCIA Token-Ring LAN Adapter
 - ❑ 3Com TokenLink III 16/4 PC card adapter (3C689)
 - ❑ IBM Auto 16/4 Credit Card Adapter
 - ❑ Olicom Token-Ring GoCard
 - ❑ Test Compatible Token-Ring+Modem COMBO Card
 - ❑ Olicom OC-2232 GoCard Token-Ring/Modem 336
 - ❑ Test Compatible PCMCIA MODEM Card
 - ❑ AT&T KeepInTouch Card 14.4 Datd/14.4 Fax
 - ❑ ActionTec DataLink 56K Fax/Modem (K56Flex)
 - ❑ Apollo FM560 Fax/Modem (K56Flex)
 - ❑ D-Link DM-336 WinConnect 33.6 Fax Modem
 - ❑ Hayes OPTIME 336 V.34 +FAX for PCMCIA
 - ❑ Lasat Credit 288 Fax/Modem
 - ❑ Megahertz XJ3288R Modem
 - ❑ Megahertz XJ-CC4288 Modem
 - ❑ Megahertz XJ4336 33.6 PC Card Modem

-
- Motorola Montana 28.8 MODEM/FAX
 - Xircom Credit Card Modem 33.6 (CM-33)
 - TDK CyberExpress 3000 V.34 Data/Fax Modem
 - TDK DF2814 V.34 Fax/Modem
 - USRobotics Sportster 28.8 Fax/Modem
 - USR Megahertz 56K PC Card Modem XJ1560
 - ZOOM Pcmcia V.34C Fax/Modem
 - Test Compatible PCMCIA COMBO Card
 - 3Com Etherlink III PCMCIA (3C562)
 - 3Com Etherlink III LAN+336 Modem (3C562C/3C563C)
 - Megahertz CC-XJEM3288 Multifunction Card
 - Motorola Maniner 28.8 Modem/Fax/Lan adapter
 - Olicom GoCard Combo Eth/Modem 336
 - Olicom GoCard Combe TRN/Modem 336
 - Xicom Creadit Card Ethernet+Modem II (CEM2)
 - Xircom Credit Card Ethernet +Modem 28.8 (PS-CEM-28)
 - Xircom Credit Card Ethernet+Modem 33.6 (CEM33)
 - Olicom OC-2232 GoCard Token-Ring/Modem 336
 - Test Compatible modem devices
 - Internal CIS 56K FAX/MODEM (internal built-in modem)
 - Ambit CIS 56K FAX/MODEM (internal built-in modem)
 - USRobotics Sportster 28800 FAX MODEM
 - ADI 33600 SVD Modem
 - Test Compatible Floppy Drive
 - Mitsumi D353F3 internal FDD
 - Test Compatible IDE Drive
 - Hitachi DK226A-21U Hard Drive
 - Hitachi DK226A-32U Hard Drive
 - IBM DKLA-23240 Hard Drive
 - IBM DKLA-24090 Hard Drive
 - IBM DTCA-23240 Hard Drive
 - IBM DTCA-24090 Hard Drive
 - TEAC 220EA-BA IDE(20X) CD-ROM
 - TEAC 220EA-25 IDE(20X) CD-ROM
 - Test Compatible Keyboard
 - Acer 6511 PS/2 (104 key)
 - Acer 6512 PS/2 (105 key)
 - Acer 6017 PS/2 (17 key keypad)
 - Microsoft Natural Keyboard PS/2 (104 key)

-
- ❑ Test Compatible Mouse
 - ❑ Acer S-34 PS/2 Mouse
 - ❑ Acer S-34 PS/2 Mouse
 - ❑ Microsoft PS/2 Mouse
 - ❑ Microsoft IntelliMouse
 - ❑ Microsoft Home Serial Mouse
 - ❑ Logitech PS/2 Mouse
 - ❑ Synaptics Internal TouchPad
 - ❑ Test Compatible Printers
 - ❑ Canon BJ-200
 - ❑ Canon LASER SHOT B406GII
 - ❑ HP LaserJet 5MP
 - ❑ HP LaserJet 6MP (ECP)
 - ❑ HP DJ890 CSE (EPP)
 - ❑ Test Compatible Monitor
 - ❑ AcerView 56e
 - ❑ AcerView 76ie
 - ❑ AcerView 98"
 - ❑ Compaq V70
 - ❑ MAG DX15F
 - ❑ NEC MultiSync XE15
 - ❑ Test Compatible USB Device
 - ❑ API Acer 6511–M Keyboard
 - ❑ Intel Camera (YC76)
 - ❑ KYE Genius NICHE USB Mouse
 - ❑ Logitech M-UA34 USB Mouse
 - ❑ Test compatible CD Titles - Education CD
 - ❑ Great Cities of World
 - ❑ Encyclopedia
 - ❑ Microsoft Bookshelf 96
 - ❑ Microsoft Cinemania 96
 - ❑ Microsoft Encarta 96
 - ❑ Microsoft Home Series CD Disc
 - ❑ Test compatible CD Titles - Photo CD
 - ❑ Powerphoto CD
 - ❑ CorelDraw Photo CD
 - ❑ Test compatible CD Titles - Music CD
 - ❑ The Great Fantasy Adventure Album

-
- Super Bass Sound
 - 3 Dimensional Sound
 - High Resolution
 - Music Highlights
 - Test compatible CD Titles - Game CD
 - Diablo
 - KKND
 - Tomb Raider
 - Mercer Mayer's Just Grandma and Me
 - Total Annihilation
 - Microsoft Golf
 - Virtua Fighter 2
 - Zoombini
 - Test compatible CD Titles - Video CD 1.x,2.0
 - Karaoke CD
 - Movies CDs

